



26TH SAE BRASIL AERODESIGN COMPETITION 2024

REGULAR, ADVANCED AND MICRO CLASSES
COMPETITION RULES

Created by the Competition Technical Committee

Revision 01

April 1st, 2024

TIPS FOR READING THIS DOCUMENT

Always observe which Competition classes each chapter or section is applicable to.

PART A

Initial section (Chapters 1 to 4): is applicable to all classes of the Competition. It contains:

- General informations about the Competition
- Competition objectives
- General behavioral rules

PART B

Introduction: General aspects of the SAE AeroDesign Competition in Brazil.

Chapter 6: Initial requirements. Valid for **Regular**, **Advanced** and **Micro** Classes.

Chapter 7: Design requirements valid ONLY for the **Regular** Class.

Chapter 8: Design requirements valid ONLY for the **Advanced** Class.

Chapter 9: Design requirements valid ONLY for the **Micro** Class.

Chapter 10: Mission requirements. Valid for **Regular**, **Advanced** and **Micro** Classes.

Chapter 11: General requirements for Reports and Presentation (Project Competition).

Valid for **Regular**, **Advanced** and **Micro** Classes.

Appendices: **Regular**, **Advanced** and **Micro** Classes, case by case.

Table of Contents

Change Log	6
1 Introduction	8
2 Competition Objectives	8
3 Contacts with SAE BRASIL and Technical Committee	8
4 General Rules	9
4.1 Previous Years	9
4.2 Rule Changes	9
4.3 Interpretation of these rules and other documents	9
4.4 Clarification of Doubts	10
4.5 Safety and Health	10
4.6 Access to Competition Operational Areas	10
4.7 Conduct	10
4.7.1 General Conduct and Safety	11
4.8 Measurements and Precision	12
4.8.1 Judges, Referees, and Technical Committee	12
4.8.2 Measuring Instruments	12
4.8.3 Verification of Measured Values	12
4.8.4 Precision of Calculations	12
4.9 Communication and Exchange of Experiences	15
4.10 Important Documents	16
4.11 Logistical Limitations and Offered Resources	17
4.12 Complaints, Protests, and Suggestions	17
4.12.1 Complaints and Protests	17
4.12.2 Suggestions	18
5 Introduction	20
6 Common Requirements - All Classes	22
6.1 Scope and Eligibility	22
6.2 Project Objective	22
6.3 Competition Organization	23
6.4 External Assistance	23
6.5 Pilot Requirements	24
6.6 Competition Registration	24
6.7 Submission of Documents in Electronic Format	25
6.8 Aircraft Configuration	25
6.8.1 Aircraft Type and Restrictions (Regular, Advanced, and Micro Classes)	25
6.9 Design Changes	26
6.10 Aircraft Identification	27
6.11 Radio Control and Receiver	29
6.12 Batteries	30
6.12.1 Flight Control Systems and Onboard Systems	30
6.12.2 Propulsion Systems	30
6.13 Installation of Arm Plugs - Electric Propulsion Systems	32
6.14 Installation of Voltwatch and On-Off - Control Systems	33

6.15	Critical Component Fixtures	34
6.16	Visibility of Structural Connections	35
6.17	Propellers	36
6.17.1	General Requirements for Propellers	36
6.17.2	Requirements for Team-Developed Propellers and Spinners	37
6.18	Use of Explosive Material	39
6.19	Control Surfaces	39
6.20	Sizing and Selection of Actuator Servomotors	39
6.20.1	Actuator Servomotors Sizing	39
6.20.2	Actuator Servomotors Originality	40
6.21	Wiring Requirements (Electronic Systems)	40
6.22	Video of a Landing and Weighing (mandatory) and other flight phases (bonus)	41
7	Requirements - Regular Class	45
7.1	Eligibility - Team Members	45
7.2	Physical Restrictions	45
7.3	Motor	47
7.3.1	Electric Motor	47
7.3.2	Motor Mounting on the Aircraft	48
7.3.3	Transmission Boxes, Belts, and Propeller Shafts	48
7.4	Cargo and Cargo Compartment	49
7.4.1	Cargo Compartment (Geometric Restrictions)	49
7.4.2	Payload	49
7.5	Electronics	51
7.5.1	Flight Control System Battery Pack	51
7.5.2	Propulsion System Battery Pack	51
7.5.3	Flight Control Systems	52
7.6	Maximum Takeoff Weight - Regular Class	52
7.7	Scoring - Regular Class	52
7.7.1	Maximum Payload [per flight battery]	52
7.7.2	Empty Weight Prediction [per flight battery]	53
7.7.3	Report Score Factor [per flight battery]	53
7.7.4	Flight Score [per flight battery]	53
7.7.5	“Accuracy” of Payload [per flight battery]	53
7.7.6	Landing Distance [per flight battery]	54
7.7.7	Cargo Removal Time [per flight battery]	54
7.7.8	Reliability Bonus [single bonus]	55
7.8	Valid Takeoff	55
8	Requirements - Advanced Class	59
8.1	Eligibility - Team Members	59
8.2	Motor	59
8.2.1	Transmission Boxes, Belts, and Propeller Shafts	60
8.3	Propulsion System Battery	60
8.4	Maximum Eligible Weight - Advanced Class	61
8.5	Electronics	61
8.5.1	Battery Packs	61
8.5.2	Flight Control Systems	61

8.6	Special Requirements for Multi-Motors	61
8.7	Multi-Mission Requirement	62
8.8	Onboard Systems Campaign Requirements	63
8.8.1	Bonus: DAS	64
8.8.2	Bonus: Autonomous Landing	66
8.8.3	Bonus: HUD	67
8.9	Performance Campaign Requirements	68
8.9.1	Payload and Cargo Compartment	68
8.9.2	Glider Jettison	69
8.10	Scoring - Advanced Class	69
8.10.1	Glider Jettison Bonus [per flight battery - Both Campaigns]	70
8.10.2	Glider Weight Bonus [per flight battery - Both Campaigns]	70
8.10.3	Maximum Loaded Payload [per flight battery - Performance Campaign]	70
8.10.4	“Accuracy” of Payload [per flight battery - Performance Campaign]	71
8.10.5	Landing Distance to Stop [per flight battery - Performance Campaign]	71
8.10.6	Cargo Removal Time [per flight battery - Performance Campaign]	71
8.10.7	Bonus for Valid Landing [per flight battery - Systems Campaign]	72
8.10.8	Data Acquisition Score [per flight battery - Systems Campaign]	73
8.10.9	HUD Bonus [per flight battery - Systems Campaign]	73
8.10.10	Quality of Parameter Recording (grading criterion)	74
8.10.11	Glider Landing Bonus [per flight battery - Systems Campaign]	75
8.10.12	Reliability Bonus [single bonus]	75
8.10.13	Multimission Scoring	76
8.11	Valid Takeoff	76
8.11.1	Valid Landing	78
9	Requirements - Micro Class	79
9.1	Eligibility - Team Members	79
9.2	Mission	79
9.2.1	Introduction	79
9.2.2	Disassembly	79
9.2.3	Assembly	80
9.2.4	Flight	82
9.3	Motor	83
9.3.1	Motor Type	83
9.3.2	Transmission Boxes, Belts, and Propeller Shafts	84
9.4	Cargo and Cargo Compartment	84
9.4.1	Gargo	84
9.4.2	Cargo Compartment	86
9.5	Disassembly and Transportation Requirements	87
9.5.1	Aircraft Specifications	87
9.5.2	Aircraft Transport Box Specifications	87
9.5.3	Aircraft Junctions Specifications	89
9.6	Electronics	89
9.6.1	Battery Pack	89
9.6.2	Flight Control Systems	90
9.7	Scoring - Micro Class	90

9.7.1	Mission Score [per flight battery]	90
9.7.2	Empty Weight Prediction [per flight battery]	90
9.7.3	Mission Time [per flight battery]	91
9.7.4	“Accuracy” of Payload Bonus [per flight battery]	91
9.7.5	Reliability Bonus [single bonus]	91
9.7.6	Minimum Volume Box Bonus [single bonus]	92
9.7.7	Bonus for assembly and disassembly process validation [one-time bonus]	92
10	Mission Requirements - All Classes	93
10.1	Flight Competition	93
10.1.1	General Flowchart	93
10.1.2	Team Workbenches	93
10.1.3	Call for Inspection	94
10.1.4	Safety Inspection	94
10.1.5	Flight Waiting Line	95
10.1.6	Valid Takeoff	96
10.1.7	Airborne Segment - Standard Circuit	99
10.1.8	Valid Landing	99
10.1.9	Standard Flight (fully valid flight)	100
10.1.10	Aircraft Condition Inspection after Flight	101
10.1.11	Removal of Cargo	102
10.1.12	Rapid Cargo Removal (Regular and Advanced)	102
10.1.13	Weighing Process	104
10.1.14	Dimensional Verification, Cargo Compartment, and Transport Box	104
10.1.15	Extraction of Data from the Acquisition System [Advanced Class Only]	104
10.2	Competition Structure and Test Batteries	105
10.2.1	Minimum Payload for Valid Flight	106
10.2.2	Considerations on Test Batteries	107
10.2.3	Final Test Battery (top-ranked teams)	107
10.3	Changes and Repairs	107
10.4	Testing at a Specific Location	108
10.4.1	Running Motors	108
10.5	Scoring	108
10.5.1	Design Competition	108
10.5.2	Flight Competition	109
10.5.3	Penalties	109
11	Report and Presentation - All Classes	110
11.1	Design Competition	110
11.2	Project Originality	111
11.3	Technical Project Reports	111
11.3.1	Submission of Reports	111
11.3.2	List of Inputs and Outputs	112
11.3.3	Report Format and Limitations	113
11.3.4	Attachments and Appendices	117
11.4	Technical Drawings	118
11.4.1	Three-View Aircraft Drawings (Technical Drawing 1)	120

11.4.2	Details of the Electrical System (Technical Drawing 6)	120
11.4.3	Assembly and Disassembly Process + Aircraft in Box [Micro class only]	121
11.4.4	Glider Technical Drawing [Advanced class only]	121
11.4.5	Open Technical Drawings	121
11.5	Payload Capacity Estimate Graph - "Accuracy"	121
11.6	Aircraft Data Template	122
11.7	Late Submission Penalty	123
11.8	Errata	124
11.9	Information Discrepancies	124
11.10	Oral Presentation	124
11.10.1	Online Phase	124
11.10.2	On location Phase	126
11.11	Feedbacks on the Project from the Judges	127
Appendices		127
1	Example of Load and Load Support	128
2	Primary and Non-primary Components	129
3	Distribution of Subjects in the Reports	130
4	Density Altitude Calculations	134
5	Three-View Drawing	135
6	Disassembled Aircraft in Box Layout (Micro Class Only)	136
7	Penalties	138
7.1	Oral Presentation	138
7.2	Aircraft Non-Conformity	138
7.3	Operational Items	139
7.4	Report - Formatting	140
7.5	Report and Other Documents - Submission	141
7.6	Technical Drawings - Formatting	142
8	Report Template for Each Subject (PDF Document)	143
9	Important Dates and Documents	146
10	Operational Flowcharts	148
11	Details of the Operational Structures	151
12	Transmission and Telematics Network	154
12.1	Introduction	154
12.2	Physical Architecture	154
12.3	Physical Characteristics of the Transceivers	156
12.4	Access Network	161
12.5	Associated Services	163
12.6	Unicast IP Address Range	164

Change Log

Revision	Date	Description
00	2024/02/04	Original publication
01	2024/04/01	<ul style="list-style-type: none"> • A reference to glow engines was removed from 6.17.2.7 • Added minimum voltage limitation for powering the Regular class propulsion system in the rule 7.5.2.2 • Increased the clarity of the use of autonomous systems in the Advanced class “Performance Campaign” in section 8.7 • Update of the Advanced Class cargo removal equation in section 8.10.6 • The minimum weight limitation for flight validation for the Advanced class in the “Systems Campaign” has been removed from rule 10.2.1.1 • Figures 11.4 and 11.5 were updated in order to better reflect the current website layout • Inclusion of the preliminary date of the competition and an update of the date of the oral presentations at appendix 9 • First version in english

Part A

1. Introduction

The SAE AeroDesign Competition has been taking place in the United States since 1986, conceived and organized by SAE International, the society that gave rise to SAE BRASIL in 1991, of which the latter is affiliated. Since 1999, this competition has also been included in the SAE BRASIL student events calendar.

Throughout all these years of existence, AeroDesign in Brazil has visibly become a growing event in both quantity and quality of participating projects. This evolution was a direct response to the technical requirements of the Competition Rules. The evolution, evident in current aircraft compared to their predecessors, is considerable, not only from a constructive point of view but also in the design methods used, the latter developed with the use of sophisticated tools created by the teams themselves. Certainly, this evolution is also reflected in each of the participants through greater learning and a more solid professional formation.

In all previous editions of the SAE AeroDesign, the Technical Committee has always had as one of its main objectives an active contribution to the professional formation of all participants. Not only an encouragement for formation in the technical area but also in organizational aspects, through the fundamental and very important teamwork, a crucial item in today's engineering world.

We hope that this edition of the SAE AeroDesign competition will be another evolutionary milestone for the teams. May the image of competence, knowledge, solidarity, friendship, and high technical level present throughout the history of AeroDesign also be present in this new competition to come. The Technical Committee feels honored and happy to create increasingly greater challenges for the teams, knowing for sure that these will be increasingly well answered.

2. Competition Objectives

- Promote a unique learning opportunity in the aeronautical field through a challenging multidisciplinary project;
- Spark interest in the aeronautical field;
- Promote technical and knowledge exchange among teams;
- Develop teamwork skills;
- Develop leadership and planning skills;
- Develop the ability to sell ideas and projects;
- Encourage ethical and professional behavior.

3. Contacts with SAE BRASIL and Technical Committee

Registration must be done through the form on the SAE BRASIL website:

WWW.SAEBRASIL.ORG.BR

Information regarding eligibility for registration is detailed in Sections 7.1, 8.1, and 9.1. The contact email with the SAE and AeroDesign Technical Committee is:

aerodesign@saebrasil.org.br

Attention: All documents, such as Enrollment Certificates, Explicit Participation Agreement, etc., must be sent to SAE BRASIL according to the specifications found on the AeroDesign website under the Information section.

Official information will preferably be disclosed on the SAE BRASIL website mentioned above or sent by email directly to the teams. **There is also an official information channel on the WhatsApp platform open to all participants.** This channel is considered an official means of communication between the Committee and the teams. However, in cases requiring more urgency or during the competition when information is more dynamic, the official Instagram page of the Technical Committee (@comissao.aerodesign) may be used, as well as the mentioned channel above. Therefore, it is recommended that at least one team member regularly monitors these channels.

4. General Rules

4.1 Previous Years

The competition for the year 2024 is entirely independent of competitions from previous years. Decisions made by the Technical Committee in previous years and rules valid for previous years are not applicable to 2024, unless explicitly stated in the documents listed in Section 4.10. Teams will be promptly informed about all decisions, procedures, and any rule changes that may occur throughout the year 2024.

4.2 Rule Changes

With no intention of harming any team, but rather to allow for a better progression of the competition, any aspect of the Rules may be altered by the Technical Committee before or during the competition, if deemed necessary. These changes will be communicated in a timely manner, and whenever possible, team captains will be consulted. It is the intention of the Technical Committee that any modification made after the release of the Rules does not affect projects already in development. A modification that might interfere with the design philosophy adopted by the team will only be made in case of extreme necessity or aiming for effective improvements in the safety of the aircraft.

4.3 Interpretation of these rules and other documents

In case of disagreement between teams and the Technical Committee regarding the interpretation of the text of this regulation, the interpretation considered will be that of the

Technical Committee. If there is a duplication of interpretation of any section of the rules, or inconsistency of information between two or more different sections of the rules, the Technical Committee should be informed. The team should not attempt to interpret these cases alone. In case of doubt, the team should proceed as presented in Section 4.4.

4.4 Clarification of Doubts

Questions regarding registration for the competition and/or submission of documents required by SAE BRASIL should be directed to SAE BRASIL. Contacts should be made through the team of the Central Office of SAE BRASIL, via the email specified in Section 3, which will forward it to the Technical Committee when necessary.

Questions regarding the technical part of the competition (Regulation and documents mentioned in Section 4.10) should be sent from the website www.aeroct.com.br, which requires in the submission:

- Email of the advisor, to which a copy of the question will be sent;
- Number of the section of these rules to which the question is related.

Note: Questions about items in these rules that can be clarified through detailed reading of the same will not be answered. Reading the complete rules of the competition is part of the challenge.

4.5 Safety and Health

SAE BRASIL will not be responsible for the individuals participating in the event. All registered participants must sign the explicit participation form and submit it to SAE BRASIL (as per Section 3). Medical insurance (mandatory, as per Section 6.1) and accident insurance are the sole responsibility of the participants.

4.6 Access to Competition Operational Areas

Each participant present in the aircraft operational areas (team areas and operational areas) must visibly carry their identification (badge and wristband) which is considered personal and non-transferable. Presentation of identification upon entering these areas is mandatory.

It is also mandatory to carry identification documents and health insurance card (see Section 6.1).

If improper use of identification (wristband and badge) or absence of the identification document along with the health insurance card is discovered, the team may be penalized as provided in **Appendix 7 Section 7.3**.

4.7 Conduct

It is important to emphasize that the AeroDesign competition is organized and conducted by volunteers, engineers, active in the aeronautical field, who understand the edu-

cational value that this initiative provides. Any action by a team, advisor, or college that is understood by the Technical Committee to be contrary to this philosophy will be punished, regardless of whether it was foreseen in the Rules or whether there have been precedents. The educational purpose is above the Rules, and it is impossible to predict all the possibilities of disrespecting it. The collaboration of everyone is of fundamental importance.

4.7.1 General Conduct and Safety

In the event of unsportsmanlike conduct, the team may initially receive a verbal or written warning from the Technical Committee. A second violation may result in severe penalties or even disqualification of the team.

The organizers, judges, or referees may prohibit any flight of any aircraft considered unsafe until these conditions are changed and the aircraft has been thoroughly re-inspected by the judges or referees.

The safety rules for the Flight Competition will be provided to all participants throughout the year and before the start of the competition. However, any action that is considered unsafe by the organizers, even if not listed on the safety rules, may be subject to penalty as per **Appendix 7 Section 7.3**.

A deliberate violation of any safety rule may result in immediate elimination of the team.

Discussion or disobedience to any judge may result in a warning or even in the elimination of the team. Members of the Technical Committee are prepared and available to resolve any doubts (or problems) that any team (or team member) may be experiencing.

It is important to remember that all Judges and Referees are volunteers and are dedicated to ensuring a successful competition for ALL involved: Teams, Sponsors, Audience, etc. We count on everyone's cooperation to ensure the success of the SAE AeroDesign Competition.

The competition organizers reserve the right to change the schedule, as well as to interpret the competition rules, at any time through their own judgment, aiming at improving the efficiency and operation of the event or safety in the competition. We hope for everyone's understanding if this becomes necessary.

Important Notices:

Smoking in the common areas of the competition will not be allowed under any circumstances due to the safety risks and health related issues that smoking can cause. Smokers should use the RESERVED SMOKING AREAS. Such areas will be indicated in the Competition layout. See "Operational Procedures - SAE AeroDesign". It should be noted that the food court is also considered an area of the Competition.

Consumption of any ALCOHOLIC BEVERAGE or any illegal chemical product is not allowed in the Competition environment. This rule applies throughout the Competition, at any stage. Any violation of this rule may result in the immediate expulsion of all members of teams from the same college, not just the team that violated it. This applies to team members and college coordinators. The SAE AeroDesign Technical Committee asks everyone to cooperate in this regard.

The Competition environment is understood to be any and all locations of the Layout defined for AeroDesign (which is demonstrated in "Operational Procedures - SAE AeroDesign") as well as throughout DCTA (which is a military base). All celebration (associated with

the consumption of alcoholic beverages) is “allowed” as long as it is done in appropriate places, outside the Competition environment and preferably at times that do not interfere with the Competition.

The Technical Committee requests moderation in the use of sound equipment, as if such equipment is very powerful, it may affect the ability of teams around to hear important announcements or calls for batteries. The use of smaller systems (sound power level up to 70 dB) is allowed, provided it does not prevent teams from hearing the calls made by the Competition announcer.

4.8 Measurements and Precision

4.8.1 Judges, Referees, and Technical Committee

Throughout the competition, judges and referees are the main measuring instruments used for any decision to be made. Their criteria and eyes are the official measures, and no decision made by them will be revoked, even if there is evidence of judgment error with footage, etc. It is not possible for SAE BRASIL or the Technical Committee to have high-precision technological resources (for example, for “millimeter-accurate” determination of whether the aircraft exceeded the takeoff limit), or even to prevent judges’ experience, knowledge, and expectations from influencing their evaluation criteria for reports. Judges and referees are trained and guided throughout the year by the Technical Committee to minimize any inaccuracies or subjectivities.

4.8.2 Measuring Instruments

In the SAE AeroDesign competition, some measuring instruments such as tapes, scales, weather stations, and others, are used to enforce the Regulation and evaluate the items that lead to the team’s score. The values measured by the competition instruments cannot be questioned with team instruments. Every measuring instrument contains inaccuracies, and therefore, they are used for all teams. Their measurements are considered true, regardless of the instrument’s precision and its error.

4.8.3 Verification of Measured Values

In the battery sheet, which contains all the information that leads to the team’s score in each battery, there is one or more fields for the signature of a team member, who must check the data and sign. If there is a disagreement about any measurement, the value can be measured again ONLY at that time. Requests for subsequent measurements will not be accepted, unless determined by the event’s Technical Committee. The battery sheets will be made available in future revisions of the regulation, well in advance of the on-site competition.

4.8.4 Precision of Calculations

From the measurements taken, with the precision of the instruments as described in Section 4.8.2, all calculations will be performed using the number of significant digits present

in the Microsoft Excel® software.

The total score (printed and electronic) will be rounded to the second decimal place. However, numerical ties will be considered between two or more sequential teams in the ranking if the score difference is equal to or less than the values in the table below:

Competition Class	Score Difference for Tie
Regular	1.0
Advanced	0.5
Micro	1.0

These values consider the precision of the measurements for each class and how measurement errors can affect the score.

Considering the tie criteria described above, the tiebreaker will be done using the highest value of the following coefficients:

Competition Class	Tiebreaker Coefficient	Section
Regular	CP	7.7.1
Advanced	B_{AD}	8.10.8
Micro	CP	9.7.1

If the tie persists, the score of the Technical Reports will be used. If there is still a tie, the Technical Committee will decide which next item will be used for tiebreak. No appeals will be allowed regarding this decision.

The tiebreaker will be counted in the form of “blocks of numerical tie”, as follows:

1. Starting from the first place, a block of teams within the tie criteria is generated, based on the first-place team of the block.
2. The tiebreaker criterion is used to determine the first-place team of the block. This team’s placement is modified to the top of the block. The other positions remain unchanged.
3. A new block is generated starting from the second place, returning to step 1 above.

Below is an example of tiebreak for the Regular Class:

1. Block 1 formed with teams within the tiebreak criteria, starting from the first place. First place (and only it) is modified according to the payload tiebreaker;

Team	Final Score	CP		Team	Pontuação Final	CP
A	204.00	12.0	Block 1 Team C passes due to CP tiebreak	C	203.00	12.2
B	203.50	12.1		A	204.00	12.0
C	203.00	12.2		B	203.50	12.1
D	202.50	12.3		D	202.50	12.3
E	202.00	11.9		E	202.00	11.9
F	201.50	11.8		F	201.50	11.8
G	201.00	12.0		G	201.00	12.0

Figura 4.1: Example tiebreak Regular Class: Block 1.

2. Block 2 formed with teams within the tiebreak criteria, starting from the second place. Teams A and B swap positions;

Team	Final Score	CP
C	203.00	12.2
A	204.00	12.0
B	203.50	12.1
D	202.50	12.3
E	202.00	11.9
F	201.50	11.8
G	201.00	12.0

Block 2
Team B passes due to CP tiebreak

Team	Final Score	CP
C	203.00	12.2
B	203.50	12.1
A	204.00	12.0
D	202.50	12.3
E	202.00	11.9
F	201.50	11.8
G	201.00	12.0

Figura 4.2: Example tiebreak Regular Class: Block 2.

3. Block 3 formed only with Team A as its subsequent is not within the difference to consider numerical tie (even though C and D are within the numerical tie, this is no longer considered due to the order of evaluation);

Team	Final Score	CP
C	203.00	12.2
B	203.50	12.1
A	204.00	12.0
D	202.50	12.3
E	202.00	11.9
F	201.50	11.8
G	201.00	12.0

Block 3
No numeric tie

Team	Final Score	CP
C	203.00	12.2
B	203.50	12.1
A	204.00	12.0
D	202.50	12.3
E	202.00	11.9
F	201.50	11.8
G	201.00	12.0

Figura 4.3: Example tiebreak Regular Class: Block 3.

4. Block 4 formed with teams within the tiebreak criteria, starting from the fourth place. First place is not modified according to payload tiebreaker. Note that, although the scores of teams B and C are within 1 point difference, they will not be used in the tiebreak as Team A could not be below Team D;

Team	Final Score	CP
C	203.00	12.2
B	203.50	12.1
A	204.00	12.0
D	202.50	12.3
E	202.00	11.9
F	201.50	11.8
G	201.00	12.0

Block 4
Team D stays ahead due to tiebreak

Team	Final Score	CP
C	203.00	12.2
B	203.50	12.1
A	204.00	12.0
D	202.50	12.3
E	202.00	11.9
F	201.50	11.8
G	201.00	12.0

Figura 4.4: Example tiebreak Regular Class: Block 4.

5. Block 5 formed with teams within the tiebreak criteria, starting from the fifth place. First place (and only it) is modified according to payload tiebreaker;

Team	Final Score	CP
C	203.00	12.2
B	203.50	12.1
A	204.00	12.0
D	202.50	12.3
E	202.00	11.9
F	201.50	11.8
G	201.00	12.0

Block 5
Team G passes due to CP tiebreak

Team	Final Score	CP
C	203.00	12.2
B	203.50	12.1
A	204.00	12.0
D	202.50	12.3
G	201.00	12.0
E	202.00	11.9
F	201.50	11.8

Figura 4.5: Example tiebreak Regular Class: Block 5.

6. Block 6 formed with teams within the tiebreak criteria, starting from the sixth place. First place is not modified according to payload tiebreaker.

Team	Final Score	CP
C	203.00	12.2
B	203.50	12.1
A	204.00	12.0
D	202.50	12.3
G	201.00	12.0
E	202.00	11.9
F	201.50	11.8

Block 6
Team E stays ahead due to tiebreak

Team	Final Score	CP
C	203.00	12.2
B	203.50	12.1
A	204.00	12.0
D	202.50	12.3
G	201.00	12.0
E	202.00	11.9
F	201.50	11.8

Figura 4.6: Example tiebreak Regular Class: Block 6.

4.9 Communication and Exchange of Experiences

The Technical Committee encourages communication among teams through:

- Participation in AeroDesign communities on the internet, social media, and similar forums.
- Recommendations of literature.
- Consulting libraries from other schools.
- Loaning of equipment and test locations.
- Internet websites.
- Display and exchange of photos.
- Discussion on test results with motors and propellers.
- Joint purchase of imported material.

- Exchange of descriptive equipment materials.
- Conversations and discussions among teams during the project or at the competition.
- Requesting feedback from the judges evaluating the Reports during the Flight Competition. Many judges evaluating the Reports also act as referees during the competition and, when available, can be consulted.
- Among others.

However, providing reports and plans from one team to another (including from the same School) is not recommended, as the discovery of necessary analyses, solutions to relevant problems, and conclusions regarding important relationships between project aspects are key to a good project and learning.

4.10 Important Documents

Documents issued by SAE BRASIL regarding the competition:

- **SAE BRASIL AeroDesign Rules 2024:** Document listing all the requirements that guide the aircraft project in the three categories: Regular Class, Advanced Class, and Micro Class. All items in this document are mandatory.
- **Registration Rules for SAE BRASIL AeroDesign 2024:** Document presenting the rules and criteria governing registration and priority order of teams for competition slots. Teams that cannot register for the SAE BRASIL AeroDesign 2024 competition can still register for the Access Tournament for the next year's SAE BRASIL competition, as detailed in this document.
- **Operational Procedures - SAE BRASIL AeroDesign:** Document addressing all the operational aspects of the SAE AeroDesign Competition that do not directly affect the aircraft project. It contains detailed explanations of various competition procedures. Its aim is to maximize the number of flights in the competition through prior dissemination of procedures.
- **Good Safety Practices Handbook - SAE BRASIL AeroDesign:** Document containing suggestions and recommendations to increase competition safety. It is extremely important for beginner teams and beginner members, even from experienced teams, to read this document to become familiar with lessons learned from all previous AeroDesign editions.
- **Messages and Bulletins:** General information about the competition, organization, side events, registration, among others. They may be mandatory or informational. Bulletins and messages are posted on the SAE BRASIL website and are numbered progressively as they are released. In case of conflicting information, the most recent one prevails.

In the event of a conflict between the above documents, the Technical Committee should be notified and consulted. Deliberately interpreting the information that best suits constitutes a highly discouraged attitude and may compromise the team's project development as well as the progress of the competition (see Section 4.3).

4.11 Logistical Limitations and Offered Resources

Teams may consist of several students, but for financial or logistical reasons, SAE BRASIL may restrict the participation of all students in some events if necessary, as well as restrict the number of meal tickets, among other items. In all these cases, students will be duly informed with the maximum possible advance notice. All team members will receive a Participation Certificate.

All resources and infrastructure that SAE BRASIL offers during the competition such as electrical power, worktables, parking, meals, kits (materials such as Regulation, caps, envelopes, sponsor kits, among others), sound system, and speakers are provided to provide more comfort during the competition, however, they are provided without any commitment, not constituting a right to receive them, even if some teams have enjoyed these resources and others have not, therefore, complaints will not be accepted due to any resource being broken, malfunctioning, running out, or any other problem.

4.12 Complaints, Protests, and Suggestions

4.12.1 Complaints and Protests

Any complaints regarding errors in scoring or other aspects of the competition must be made to the Technical Committee during the course of the competition.

Complaints must be identified and signed by the captain of the complaining team. Written complaints should be submitted to a Technical Committee representative and will be duly analyzed as soon as possible during the competition.

If pertinent, the Technical Committee will take the necessary actions with proper notification to the complaining team, as soon as possible, and at most by the day after the form is submitted. Complaints made on the last day of the competition will receive a response within 10 days after the competition, before the official score announcement.

Unfounded complaints regarding other teams may result in penalties for the complaining team. The penalty will be assessed on a case-by-case basis by the Technical Committee. For example: if a complaint is made against another team that is found to be false during the investigation, causing embarrassment and loss of time for the accused team, it may result in a penalty for the complaining team.

Complaints about the score announced at the awards ceremony should be sent to the Technical Committee via email within the deadline specified in **Appendix 9**.

The decision of the Technical Committee will be final and irrevocable, provided in writing and disclosed during or after the competition. Any argumentation with the Technical Committee or any of the judges and referees, after the decision has been made, may result in a penalty according to **Appendix 7 (Section 7.3)**. Insisting on discussing decisions of the Technical Committee that are supported by the Regulation, i.e., insisting on exceptions to the Regulation for any reason, may result in similar penalties.

Any unsportsmanlike conduct by the team (or team member) (e.g., extreme verbal aggressions towards anyone in the competition environment) may result in the prohibition of the college's participation in up to two subsequent competitions. AeroDesign in Brazil has had an extremely friendly environment of friendship and collaboration among all teams,

volunteers, and collaborators since its first edition, and therefore, it is the responsibility of everyone to maintain this excellent environment.

It is the obligation of any participant to inform the Competition's Technical Committee (yellow shirts) about any safety issues. If any aspect or characteristic, whether of an aircraft or installation in the competition environment, is identified that compromises the safety of flight or the attending public, it must be immediately reported to the safety officer. All items identified will be evaluated by the Technical Committee, and there will be no further discussions regarding the final decision of the Committee.

4.12.2 Suggestions

During the competition, the Technical Committee is always open to receive suggestions and discuss the competition. In a more official and controlled manner, after the competition, teams will be invited to participate in an online survey where they can provide suggestions and criticisms on various aspects of the competition.

The Technical Committee encourages all teams to fill out the survey with criticisms and/or suggestions of any nature.

Such suggestions are extremely important for the continuous improvement of the Competition in all aspects. Several of them have already been used to improve the event, and therefore, it is always very enriching to know everyone's opinion.

We reiterate that the collaboration of ALL participants is an essential factor for the success and growth of the SAE BRASIL AeroDesign Competition.

Part B

5. Introduction

The AeroDesign Project consists of an engineering competition open to undergraduate and graduate students in engineering fields related to mobility. It is organized by SAE BRASIL (Society of Mobility Engineers) fulfilling one of its missions: to contribute to the academic formation of future mobility professionals.

The competition offers a unique opportunity for students, organized in teams, to develop an aeronautical project in all its stages, from conception, project detailing, construction, and testing, to effectively putting it to the test against other similar projects. Students are encouraged to develop important skills for their future careers: leadership, teamwork, planning, and the ability to sell projects and ideas.

The SAE BRASIL AeroDesign Competition has institutional support from the Ministry of Education of Brazil, as it aligns with and meets the objectives of the policies and guidelines of this Ministry.

The top-ranked teams in the three categories will be awarded. All information regarding the awards will be recorded in the document **Operational Procedures - SAE AeroDesign** as well as in a specific message that will be sent to all teams at the appropriate time.

With the aim of competing in the 2024 edition of the SAE BRASIL AeroDesign Competition, each competing team must conceive, design, document, build, and fly a radio-controlled aircraft that is as optimized as possible in all aspects of the mission, through creative, innovative, and multidisciplinary design solutions that meet the requirements and constraints imposed in these Rules. Some additional design challenges, especially developed for 2024, are described throughout the Rules, and others are encouraged through bonuses. Several aspects must be observed to ensure the success of the project:

- Careful analysis of the Competition Rules.
- Consistent conceptual and preliminary design.
- Definition and/or elaboration of the design methodology.
- Development and/or definition of analysis tools (calculations).
- Detailed project construction.
- Construction, construction quality, robustness, and reliability of the project.
- Preparation and development of engineering tests.
- Preparation of the report.
- Planning and preparation of the oral presentation.
- Flight competition.

In addition to the technical requirements, the team must concern itself with various other aspects to achieve project success:

- Seeking sponsorship (financial support).
- Planning.
- Effective leadership.
- Teamwork.
- Logistics.

- Communication skills.
- Interpretation of rules and additional documents (see Sections 4.10 and 4.3).
- Creativity and innovation.
- Having a sportsmanlike spirit.

All these aspects are part of the challenge, and their practice during an undergraduate course complements the technical aspects learned in the classroom or from books. Projects are judged by a variety of areas.

The total score encompasses the following items:

- Project Competition
- Flight Competition

6. Common Requirements - All Classes

In order to facilitate the understanding and verification of compliance with these Rules, all obligatory itens of this document will be treated as requirements, having a consequence of non-compliance and a verification process associated. Throughout the text, the following template will be found:

- **R[n.n.n.n]**: This code indicates a unique identification number of the requirement. This numbering aims to facilitate traceability and verification of requirements. Each requirement must have associated two similar codes NC and VV as below;
- **NC[n.n.n.n]**: Indicates the consequence for the team in case of Non-Compliance or non-compliance with the requirement of the same number;
- **VV[n.n.n.n]**: Indicates the form, stage of the competition, or process in which the Verification and Validation of the requirement of the same number will be carried out.

6.1 Scope and Eligibility

R[6.1.0.1] Participants must be current members of SAE BRASIL at the time of team registration for both phases: online and on location.

NC[6.1.0.1] Registration not accepted.

VV[6.1.0.1] Member registration process.

R[6.1.0.2] Participants must have Health Insurance (private or public) valid on the event date and accepted in São José dos Campos.

NC[6.1.0.2] Registration not accepted.

VV[6.1.0.2] Member registration process.

R[6.1.0.3] During the event, all participants (Members, Pilot, Captain, and Advisor) must carry the Health Insurance card regardless of the Plan.

NC[6.1.0.3] Unauthorized access to the competition area.

VV[6.1.0.3] Access control to the competition area.

In case of an accident at the event venue, an ambulance will transport the injured person to a location accepted by their plan. A team member must accompany them to the care location. The event does not proceed in the absence of an ambulance.

6.2 Project Objective

The team must design, build, and test an original radio-controlled airplane that is as optimized as possible in all aspects of the mission, through creative, innovative, and multidisciplinary design solutions that meet the requirements and restrictions imposed in the Rules. Some additional design challenges are described throughout the Rules and encouraged through bonuses.

6.3 Competition Organization

The Competition is divided in two parts:

- **Project Competition** - teams will present their projects and demonstrate their calculations to determine the maximum score the aircraft can obtain as well as the various criteria used to define the aircraft. In this context, “project” is understood as all the reasoning, duly justified, used to conceive the aircraft proposal developed by the team to participate in the Competition.
- **Flight Competition** - determines the maximum load each aircraft can carry, structural efficiency, actual empty weight (PV) of the aircraft, its reliability, and various other aspects. Design accuracy and construction precision are also taken into account in the result. The items scored in the flight competition vary according to the category (Regular, Advanced, and Micro).

Although the Competition for the Regular, Advanced, and Micro classes is held simultaneously, the evaluation of each of the classes will be done separately.

6.4 External Assistance

- R[6.4.0.1]** The aircraft design must be exclusively executed by team members, with any external consulting on the design prohibited.
- NC[6.4.0.1]** Team disqualification.
- VV[6.4.0.1]** Report evaluation and safety inspection.

- R[6.4.0.2]** The aircraft construction must be exclusively carried out by team members, except for processes that require specific machinery, such as laser cutting, machining, etc.
- NC[6.4.0.2]** Team disqualification.
- VV[6.4.0.2]** Report evaluation and safety inspection.

- R[6.4.0.3]** The aircraft testing must be performed exclusively by team members.
- NC[6.4.0.3]** Team disqualification.
- VV[6.4.0.3]** Report evaluation and safety inspection.

The Pilot does not need to be a team member, as per Section 6.5.

- R[6.4.0.4]** The team must present their project in a report meeting the requirements of Sections 11.2 to 11.9.
- NC[6.4.0.4]** Report not accepted or penalized.
- VV[6.4.0.4]** Report evaluation.

- R[6.4.0.5]** The team must present their project in an oral presentation during the event meeting the requirements of Sections 11.2 and 11.10.

NC[6.4.0.5] Oral presentation not accepted or penalized.

VV[6.4.0.5] Oral presentation evaluation.

R[6.4.0.6] The team must fly their aircraft during the event meeting the requirements of Chapter 10.

NC[6.4.0.6] Flight invalidated or team disqualified.

VV[6.4.0.6] Safety inspection, procedures executed on the runway, and post-flight inspection.

6.5 Pilot Requirements

Although the aircraft design and construction must necessarily be authored by the students who make up each team, the pilot does not need to be a team member and does not need to be associated with SAE BRASIL. However, the team wishing to use its own pilot must meet the following requirements.

R[6.5.0.1] The pilot must prove their experience by completing the document found on the portal www.aeroct.com.br.

NC[6.5.0.1] Pilot not accepted, and the team must use an SAE Pilot.

VV[6.5.0.1] Registration process.

R[6.5.0.2] The pilot or team must fill out and submit the Pilot Registration form through the website www.aeroct.com.br considering the reference deadline in **Appendix 9**.

NC[6.5.0.2] Pilot not registered, and the team must use an SAE Pilot.

VV[6.5.0.2] Registration process.

R[6.5.0.3] For pilot changes, the team must update the Pilot Registration form through the website www.aeroct.com.br considering the reference deadline in **Appendix 9**.

NC[6.5.0.3] Change not accepted, and the team must use an SAE Pilot.

VV[6.5.0.3] Registration process.

6.6 Competition Registration

The registration form is available on the SAE BRASIL website (see Chapter 3 of this document).

The entire registration process for 2024 is described in the document **Registration Rules for SAE BRASIL AeroDesign 2024** mentioned in Section 4.10. This document regulates the registration for both the SAE BRASIL AeroDesign 2024 competition and the Access Tournament for the following year's competition.

6.7 Submission of Documents in Electronic Format

R[6.7.0.1] Text documents and reports must be submitted in PDF format.

NC[6.7.0.1] Document not accepted.

VV[6.7.0.1] Registration process and website www.aeroct.com.br.

R[6.7.0.2] Figures, drawings, and technical drawings must be submitted in PDF or JPG format.

NC[6.7.0.2] Document not accepted.

VV[6.7.0.2] Website www.aeroct.com.br.

R[6.7.0.3] Videos must be submitted through links on YouTube.

NC[6.7.0.3] Document not accepted.

VV[6.7.0.3] Website www.aeroct.com.br.

R[6.7.0.4] No document sent via email should exceed the maximum size of 5 Mb.

NC[6.7.0.4] Document not accepted.

VV[6.7.0.4] Document submission.

Documents sent to the Technical Committee through upload on the website www.aeroct.com.br may be limited as appropriate. The maximum sizes of these files will be specified on the website and, when applicable, in the respective sections of these Regulations.

In specific cases, and only when the **Rules require**, or are requested during the course of this competition, another format may be used.

Extra technical drawings and/or drawings, when requested by the Technical Committee, must be submitted in accordance with requirement R[6.7.0.2]. Files in SolidWorks®, CATIA®, AutoCAD®, or similar will not be accepted. Regarding the Project Report, see Section 11.3.

6.8 Aircraft Configuration

6.8.1 Aircraft Type and Restrictions (Regular, Advanced, and Micro Classes)

R[6.8.1.1] The aircraft must be fixed-wing.

NC[6.8.1.1] Aircraft prohibited from participating in the competition.

VV[6.8.1.1] Evaluation of report and safety inspection.

R[6.8.1.2] The aircraft must not use lighter-than-air gas to generate lift.

NC[6.8.1.2] Aircraft prohibited from participating in the competition.

VV[6.8.1.2] Evaluation of report and safety inspection.

- R[6.8.1.3] The wing structure must be entirely composed of rigid elements.
NC[6.8.1.3] Aircraft prohibited from participating in the competition.
VV[6.8.1.3] Evaluation of report and safety inspection.

Examples of wings not accepted for having non-rigid elements: parachutes, paragliders, etc.

- R[6.8.1.4] The aircraft must not use auxiliary takeoff devices that are not part of the aircraft and/or that will not be physically connected to the plane when it lands.
NC[6.8.1.4] Aircraft prohibited from participating in the competition.
VV[6.8.1.4] Evaluation of report and safety inspection.

- R[6.8.1.5] The aircraft must not have any type of auxiliary propulsion, on the ground or in flight, other than the own engine.
NC[6.8.1.5] Aircraft prohibited from participating in the competition.
VV[6.8.1.5] Evaluation of report and safety inspection.

- R[6.8.1.6] The aircraft must not have any type of cutting edge or sharp edge that could cause injury during the competition.
NC[6.8.1.6] Aircraft prohibited from participating in the competition.
VV[6.8.1.6] Evaluation of report and safety inspection.

6.9 Design Changes

If necessary, teams can make changes to the aircraft, so that the plane taken to the competition is not in conformity with the aircraft presented in the project report. These design changes may or may not be penalized depending on the degree of modification. This judgment is the responsibility of the Technical Committee. In general, the following rules apply:

- Design changes aimed at safety are less penalized than those aimed at performance;
- Design changes delivered as soon as possible are less penalized than those delivered late;
- Design changes communicated by the team, based on transparency and honesty, are less penalized than those detected by the Technical Committee and not previously communicated.

The penalty is based on how much the team can gain in performance (and score) with the modification in question, multiplied by a factor that depends on the need for the modification for flight safety.

The Technical Committee will not indicate an approximate penalty before receiving the project report. It is understood that the modifications are necessary for the safety of the aircraft, and the penalty should not interfere with the team's choice of whether or not to modify the design.

- R[6.9.0.1]** Reports of design changes must be submitted by the deadline in **Appendix 9**.
NC[6.9.0.1] Penalties increase as the competition approaches.
VV[6.9.0.1] Document submission.

- R[6.9.0.2]** The Design Change report must have a maximum of 5 pages (reference value).
NC[6.9.0.2] Report rejected and the team will be requested to submit a new document.
VV[6.9.0.2] Document submission.

- R[6.9.0.3]** The Design Change report must be objective, showing only the modifications and their reasons.
NC[6.9.0.3] Report rejected and the team will be requested to submit a new document.
VV[6.9.0.3] Document submission.

- R[6.9.0.4]** The Design Change report must be submitted through the portal www.aeroct.com.br or delivered personally to a member of the Technical Committee, if the change occurs during the competition.
NC[6.9.0.4] Report rejected and the team will be requested to submit a new document.
VV[6.9.0.4] Document submission.

Design changes are solely intended to correct the aircraft. Under no circumstances should design changes be associated with errata from the report, project technical drawings, and data submitted on the website www.aeroct.com.br. The design data provided in the project competition is immutable (see Sections 11.8 and 11.9).

6.10 Aircraft Identification

- R[6.10.0.1]** The aircraft must have the team number clearly displayed on both sides of the vertical tail and on the wing's upper surface.
NC[6.10.0.1] Non-compliance correction or aircraft will be prohibited from flying.
VV[6.10.0.1] Safety inspection: the team number on the aircraft must be identifiable by a person at a distance of 10 m (approximate reference value).

To comply with **R[6.10.0.1]**, it is suggested that the number be at least 100 mm in height. It is also suggested to include the team name and institution abbreviation on the wing's upper surface. The team number is determined by SAE BRASIL and the Technical Committee.

- R[6.10.0.2]** The aircraft must have the identification number generated by the SISANT system of ANAC affixed in a visible location on the aircraft, requiring 1 (one) registration per aircraft according to the informative message to be disclosed on the SAE website.
NC[6.10.0.2] Non-compliance correction or aircraft will be prohibited from flying.
VV[6.10.0.2] Safety inspection: the identification number must be easily identifiable on the aircraft during safety inspection.

To comply with R[6.10.0.2], teams must complete the registration described in the message titled “Aircraft registration with ANAC”, available on the website <https://saebrasil.org.br/programas-estudantis/aero-design-sae-brasil>.

R[6.10.0.3] Aircraft in the Regular, Advanced, and Micro classes carrying sponsor logos, supporting institutions, and/or representing educational institutions must include the SAE BRASIL and SAE AeroDesign Competition logos on each of the half-wings as follows:

Regular and Advanced Class Aircraft: SAE Brasil logo with dimensions of 28 X 4 cm⁽¹⁾ positioned 25% of the wing span from the root. The logo must be positioned on the wing’s upper surface with the larger dimension (28 cm) along the span. SAE AeroDesign Competition logo with approximate dimensions of 16.8 X 7 cm⁽¹⁾ positioned 25% of the wing span from the root. The logo must be positioned on the wing’s upper surface with the larger dimension (16.8 cm) along the span and in the same reading direction as the SAE Brasil logo.



Figura 6.1: SAE BRASIL and Competition logos must appear on the half-wings of competing aircraft.

Micro Class Aircraft: SAE BRASIL logo with dimensions of 17.5 X 2.5 cm⁽¹⁾ positioned 25% of the wing span from the root. The logo must be positioned on the wing’s upper surface with the larger dimension (17.5 cm) along the span. SAE AeroDesign Competition logo with approximate dimensions of 12 X 5 cm⁽¹⁾ positioned 25% of the wing span from the root. The logo must be positioned on the wing’s upper surface with the larger dimension (12cm) along the span and in the same reading direction as the SAE Brasil logo.

(1) Dimensions according to official proportions of the SAE BRASIL and SAE AeroDesign Competition logos.

NC[6.10.0.3] Non-compliance correction or aircraft will be prohibited from flying.

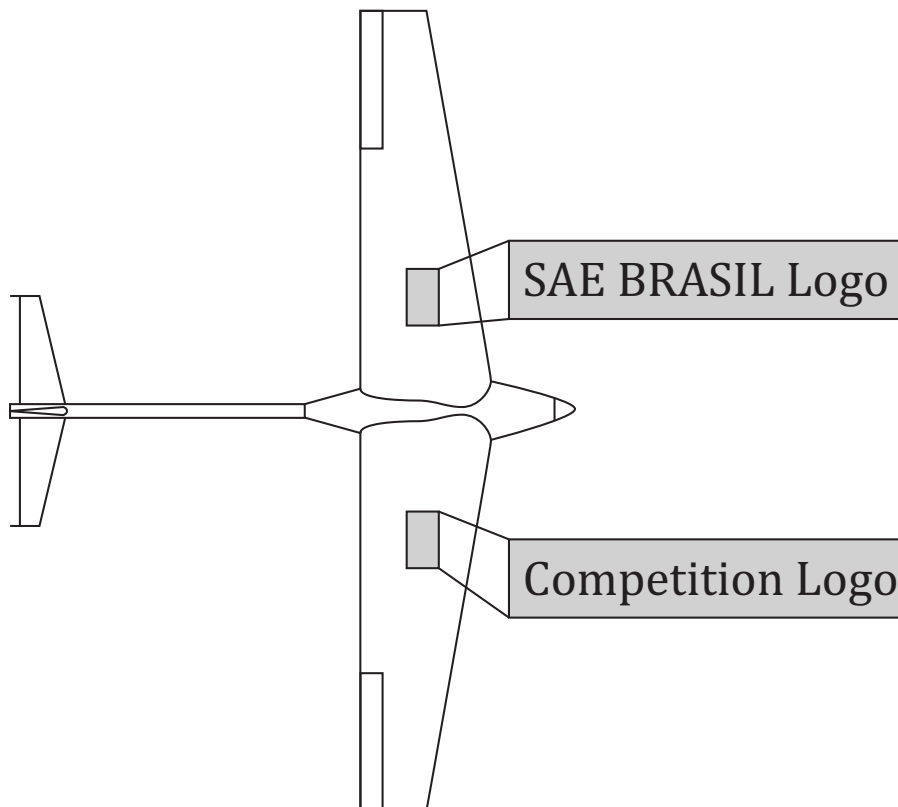
VV[6.10.0.3] Safety inspection.

6.11 Radio Control and Receiver

R[6.11.0.1] The use of 2.4 GHz radios is mandatory.

NC[6.11.0.1] Non-compliance correction or aircraft will be prohibited from flying.

VV[6.11.0.1] Safety inspection.

R[6.11.0.2] The team must provide means to protect the radio in case of flight under rainy conditions.

NC[6.11.0.2] Non-compliance correction or aircraft will be prohibited from flying.

VV[6.11.0.2] Safety inspection.

R[6.11.0.3] Radios must be in good condition.

NC[6.11.0.3] Non-compliance correction or aircraft will be prohibited from flying.

VV[6.11.0.3] Safety inspection.

R[6.11.0.4] The receiver must be visible to officials during safety inspections.

NC[6.11.0.4] Non-compliance correction or aircraft will be prohibited from flying.

VV[6.11.0.4] Safety inspection.

R[6.11.0.5] The receiver must be protected against vibrations.

NC[6.11.0.5] Non-compliance correction or aircraft will be prohibited from flying.

VV[6.11.0.5] Safety inspection.

R[6.11.0.6] Antennas must not be in contact with carbon or metal parts.

NC[6.11.0.6] Non-compliance correction or aircraft will be prohibited from flying.

VV[6.11.0.6] Safety inspection.

R[6.11.0.7] The aircraft's control systems and receiver must be protected from airflow to ensure operation in case of flight during rain.

NC[6.11.0.7] Non-compliance correction or Aircraft prohibited from flying in any weather condition.

VV[6.11.0.7] Safety inspection.

6.12 Batteries

6.12.1 Flight Control Systems and Onboard Systems

R[6.12.1.1] For flight control systems, the team must use only batteries from the permitted types, as listed below:

- Nickel Cadmium (NiCd)
- Nickel Metal Hydride (NiMH)
- Lithium Iron Phosphate (LiFePO₄)

NC[6.12.1.1] Non-compliance correction or the aircraft will be grounded.

VV[6.12.1.1] Safety inspection.

R[6.12.1.2] The batteries for flight control systems and onboard systems must be commercial; teams are not allowed to manufacture or modify them from the connector to the cells.

NC[6.12.1.2] Non-compliance correction or the aircraft will be grounded.

VV[6.12.1.2] Safety inspection.

R[6.12.1.3] Battery charging must comply with safety standards for each battery type.

NC[6.12.1.3] Team disqualification.

VV[6.12.1.3] All stages of the Competition.

R[6.12.1.4] Lithium Ion Polymer (LiPO) batteries must not be used in aircraft control systems, on-board systems, or support tools such as starters.

NC[6.12.1.4] Battery confiscation until the end of the competition.

VV[6.12.1.4] All stages of the Competition.

6.12.2 Propulsion Systems

R[6.12.2.1] For electric motor power supply, the team must use only batteries from the permitted types, as listed below:

- Nickel Cadmium (NiCd)
- Nickel Metal Hydride (NiMH)
- Lithium Iron Phosphate (LiFePO₄)
- Lithium Polymer Ion (LiPO)

NC[6.12.2.1] Non-compliance correction or the aircraft will be grounded.

VV[6.12.2.1] Safety inspection.

R[6.12.2.2] Aircraft with electric motor must have a dedicated battery for the propulsion system, separate from the battery powering the control surfaces.

NC[6.12.2.2] Non-compliance correction or the aircraft will be grounded.

VV[6.12.2.2] Safety inspection.

R[6.12.2.3] The battery must be secured in a location free from other aircraft equipment or components that may puncture it in the event of an aircraft crash.

NC[6.12.2.3] Non-compliance correction or the aircraft will be grounded.

VV[6.12.2.3] Safety inspection.

R[6.12.2.4] Battery charging must comply with safety standards for each battery type.

NC[6.12.2.4] Team disqualification.

VV[6.12.2.4] All stages of the Competition.

R[6.12.2.5] For charging Lithium Ion Polymer (LiPO) batteries, the team must place the battery in a commercial safety bag.

NC[6.12.2.5] Team disqualification.

VV[6.12.2.5] All stages of the Competition.



Figura 6.2: Examples of safety bags for LiPO batteries.

R[6.12.2.6] For charging Lithium Ion Polymer (LiPO) batteries, the team must use the Charging Location to be disclosed during the competition.

NC[6.12.2.6] Team disqualification.

VV[6.12.2.6] All stages of the Competition.

Given that charging positions are limited, that many teams use the workbenches provided, and that there is a limited power supply available during the competition, it is recommended that teams:

- bring batteries, including reserves, fully charged for flight days;
- identify their batteries and chargers with stickers to avoid swapping at the charging station;

- bring 12V vehicle-type batteries, or similar, to charge LiPO batteries using commercial chargers, provided they comply with the procedures of rules **R[6.12.2.5]** and **R[6.12.2.6]** and use ring terminals on the vehicle battery terminals. The use of clamp or “crocodile” connectors will not be allowed, and the team will be prevented from charging under these circumstances.

Power outages may occur during the competition due to various reasons beyond the Technical Committee’s control. Teams should be aware of this fact and avoid critical situations where their respective flights are impacted by such events.

R[6.12.2.7] Teams may use commercial or self-made batteries for the propulsion system. Self-made batteries must be manufactured using commercial cylindrical or prismatic cells, with pouch-type cells not allowed. For self-made batteries, individual cell balancing terminals must be present, and only spot welding may be used at the interface of any conductors with the cells, with no soldering or brazing allowed under this condition. Battery cells must form structurally stable assemblies without relying on the conductors connected to them, and their design with relevant tests and/or manufacturer documentation must be submitted to the Technical Committee via www.aerocf.com.br in a specific field, with the Technical Committee having the authority to authorize or not the use of a battery.

NC[6.12.2.7] Non-compliance correction or the aircraft will be grounded, and the battery will be prohibited from the competition venue.

VV[6.12.2.7] All stages of the Competition.

The Committee reserves the right to prohibit charging under conditions not mentioned above but which compromise safety in any way.

6.13 Installation of Arm Plugs - Electric Propulsion Systems

R[6.13.0.1] Aircraft using electric motors must use a removable arm plug-style device to activate or deactivate the motor supply.

NC[6.13.0.1] Correction of non-compliance or the aircraft will be prevented from flying.

VV[6.13.0.1] Safety inspection.

R[6.13.0.2] The fixed part of the safety device cannot have more than one “male” conductor and must be in a visible, accessible location, and at a safe distance from the plane of the propeller.

NC[6.13.0.2] Correction of non-compliance or the aircraft will be prevented from flying.

VV[6.13.0.2] Safety inspection.



Figura 6.3: Example of an “arm plug” for propulsion systems.

6.14 Installation of Voltwatch and On-Off - Control Systems

R[6.14.0.1] The aircraft must have a commercial and independent VoltWatch Receiver Battery Monitor, with computerized or integrated VoltWatches not allowed in control systems.

NC[6.14.0.1] Correction of non-compliance or the aircraft will be prevented from flying.

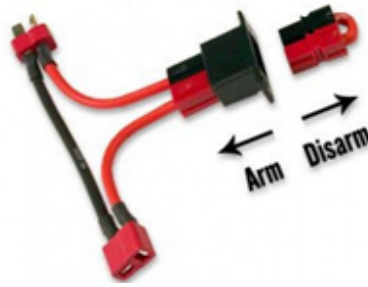
VV[6.14.0.1] Safety inspection.

For aircraft using electric motor propulsion, the VoltWatch is mandatory only for the battery that powers the control surfaces. The available charge in the propulsion system battery is a responsibility of the team.

R[6.14.0.2] The aircraft must fly with the VoltWatch installed and active.

NC[6.14.0.2] Correction of non-compliance or the aircraft will be prevented from flying.

VV[6.14.0.2] Safety inspection and procedures executed on the runway.

R[6.14.0.3] The VoltWatch must be connected directly to the flight control system battery (before voltage regulators, if any) and available on the aircraft whenever the battery is connected.

NC[6.14.0.3] Correction of non-compliance or the aircraft will be prevented from flying.

VV[6.14.0.3] Safety inspection.

R[6.14.0.4] The VoltWatch must be **VISIBLE** so that the battery charge can be checked immediately before all takeoffs.

NC[6.14.0.4] Correction of non-compliance or the aircraft will be prevented from flying.

VV[6.14.0.4] Safety inspection and procedures executed on the runway.

R[6.14.0.5] The VoltWatch must be commercial.

NC[6.14.0.5] Correction of non-compliance or the aircraft will be prevented from flying.

VV[6.14.0.5] Safety inspection.



Figura 6.4: Example of a VoltWatch for NiCd or NiMH batteries.



Figura 6.5: Examples of VoltWatch for LiFePO₄ batteries.

R[6.14.0.6] The aircraft must have an On-Off switch for the receiver and servomotors.

NC[6.14.0.6] Correction of non-compliance or the aircraft will be prevented from flying.

VV[6.14.0.6] Safety inspection.

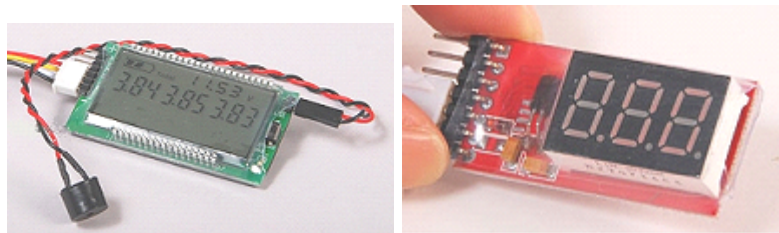
The option to install an On-Off switch for electric motors and data acquisition systems is at the discretion of the team.

6.15 Critical Component Fixtures

The following components are considered critical and deserve special attention when assembled:

- Structural connections (wing-fuselage, empennage, landing gear, etc.);
- Motor fastenings;
- Payload fastenings on the aircraft.

For these critical connections, the following recommendations apply to all categories:

- Connections by means of metallic screws and self-locking or braked nuts are authorized and recommended;
- For this type of fastenings described below, a rigorous evaluation will be carried out at the safety inspection (Subsection 10.1.4). If there is any risk of component loosening due to static, dynamic forces, or vibration, the aircraft may fail the inspection or modifications may be requested. Fastenings by means of:
 - – Metallic screws and nut/washer assembly, and/or nuts glued with appropriate adhesive;
 are authorized, but not recommended.

R[6.15.0.1] All critical items must be securely fastened.

NC[6.15.0.1] Correction of non-compliance or the aircraft will be prevented from flying.

VV[6.15.0.1] Safety inspection.

R[6.15.0.2] No item, critical or not, should be capable of coming loose in flight.

NC[6.15.0.2] Correction of non-compliance or the aircraft will be prevented from flying.

VV[6.15.0.2] Safety inspection.

R[6.15.0.3] Fixation by Velcro® on critical components should not be used.

NC[6.15.0.3] Correction of non-compliance or the aircraft will be prevented from flying.

VV[6.15.0.3] Safety inspection.

R[6.15.0.4] Fixation by elastic or rubber on critical components should not be used.

NC[6.15.0.4] Correction of non-compliance or the aircraft will be prevented from flying.

VV[6.15.0.4] Safety inspection.

R[6.15.0.5] Fixation by nylon screws or other polymers on critical components should not be used.

NC[6.15.0.5] Correction of non-compliance or the aircraft will be prevented from flying.

VV[6.15.0.5] Safety inspection.

R[6.15.0.6] Fixation by self-tapping screws on critical components should not be used.

NC[6.15.0.6] Correction of non-compliance or the aircraft will be prevented from flying.

VV[6.15.0.6] Safety inspection.

It is recommended to read the document **Good Safety Practices Handbook** for more information.

6.16 Visibility of Structural Connections

Structural connections (load path) refer to all connections between the components of the aircraft.

The following structural connections, if they exist, will be considered critical structural connections:

- Fuselage / wing connections
- Fuselage / empennage connections
- Fuselage / tail boom connections
- Tail boom / wing connections
- Tail boom / empennage connections
- Vertical tail connection to horizontal tail
- Motor / fuselage connections

- Wing / wing connections (in the case of segmented wings, the spar joint must be visible)

If any case different from those mentioned above is detected, the Technical Committee may deliberate on such exception during the safety inspection.

R[6.16.0.1] Critical structural connections must be visible and/or verifiable during the safety inspection with the assembled aircraft.

NC[6.16.0.1] The team may be asked to tear the covering during the safety inspection to allow visualization of the structure.

VV[6.16.0.1] Safety inspection.

It is also desirable that critical regions of the wing spar, even where there are no connections, be visible.

6.17 Propellers

6.17.1 General Requirements for Propellers

R[6.17.1.1] Metal-bladed propellers must not be used.

NC[6.17.1.1] Correction of nonconformity or the aircraft will be prevented from flying.

VV[6.17.1.1] Safety inspection.

Metal hubs, spinners, or counterweights are allowed.

R[6.17.1.2] Repaired propellers must not be used.

NC[6.17.1.2] Correction of nonconformity or the aircraft will be prevented from flying.

VV[6.17.1.2] Safety inspection.

R[6.17.1.3] The propeller must be securely attached to the aircraft.

NC[6.17.1.3] Correction of nonconformity or the aircraft will be prevented from flying.

VV[6.17.1.3] Safety inspection.

The propeller should preferably be fastened with a self-locking nut. Plastic spinners or commercial aluminum spinner nuts are allowed but not recommended.

R[6.17.1.4] Propellers must not be attached using elastic bands, rubber, or any other polymer.

NC[6.17.1.4] Correction of nonconformity or the aircraft will be prevented from flying.

VV[6.17.1.4] Safety inspection.

R[6.17.1.5] Propellers and spinners manufactured by the team and single-blade propellers (even if commercial) must undergo the required tests in Subsection 6.17.2.

NC[6.17.1.5] The use of the propeller and/or spinner will not be authorized.

VV[6.17.1.5] Evaluation of propeller design report.

6.17.2 Requirements for Team-Developed Propellers and Spinners

Teams wishing to use propellers or spinners manufactured by the team (non-commercial), or single-blade propellers (commercial or not) must submit a **Propeller Design Technical Report** meeting the following requirements.

- R[6.17.2.1]** The Propeller and/or Spinner Design Technical Report must be submitted to the Technical Committee via the website www.aeroct.com.br.
- NC[6.17.2.1]** The use of the propeller will not be authorized.
- VV[6.17.2.1]** Document submission and website www.aeroct.com.br.
- R[6.17.2.2]** The Propeller and/or Spinner Design Technical Report must have a maximum of five pages (reference value).
- NC[6.17.2.2]** Report rejected, and the team will be asked to submit a new document.
- VV[6.17.2.2]** Report evaluation.
- R[6.17.2.3]** The Propeller and/or Spinner Design Report must contain a performance analysis of the component, justifying the team's choice to use it.
- NC[6.17.2.3]** The use of the propeller and/or spinner will not be authorized.
- VV[6.17.2.3]** Report evaluation.
- R[6.17.2.4]** The Propeller and/or Spinner Design Report must contain a safety analysis, including theoretical analysis, demonstration of maximum bending, torsion, and tension (centrifugal) loads supported, including all these loads simultaneously.
- NC[6.17.2.4]** The use of the propeller and/or spinner will not be authorized.
- VV[6.17.2.4]** Report evaluation.
- R[6.17.2.5]** The Propeller and/or Spinner Design Report must contain photos of static tests performed with applied loads to simulate bending, torsion, and centrifugal force, and the test results.
- NC[6.17.2.5]** The use of the propeller and/or spinner will not be authorized.
- VV[6.17.2.5]** Report evaluation.
- R[6.17.2.6]** Each propeller produced by the team must be marked with a serial number.
- NC[6.17.2.6]** The use of the propeller and/or spinner without the serial number will not be authorized.
- VV[6.17.2.6]** Safety inspection.
- R[6.17.2.7]** For each serial number, a video of a test performed at 100% of the maximum motor rotation chosen for a minimum period of 3 minutes must be posted on YouTube. In this test, the team must use the motor used by the team for the competition and adjust the accelerator to reach the maximum rotation.

NC[6.17.2.7] The use of the propeller and/or spinner from the untested serial number will not be authorized.

VV[6.17.2.7] Document submission.

The test of each serial number aims to increase the competition's safety, ensuring that the manufacturing process does not affect the component's quality.

R[6.17.2.8] For each serial number, a video using a higher-power motor (combustion or electric, for model aircraft or not) of the execution of a test at 120% of the maximum rotation defined in requirement R[6.17.2.7].

NC[6.17.2.8] The use of the propeller and/or spinner will not be authorized.

VV[6.17.2.8] Document submission.

R[6.17.2.9] As an alternative to requirement R[6.17.2.8], a static test is accepted. In this test, the traction, bending, and torsion loads used must be at least 150% of the loads found with a test at 120% of the maximum rotation defined in requirement R[6.17.2.7].

NC[6.17.2.9] The use of the propeller and/or spinner will not be authorized.

VV[6.17.2.9] Document submission.

R[6.17.2.10] The links of the videos of requirements R[6.17.2.7] and R[6.17.2.8] for at least one serial number must be explicit in the Propeller and/or Spinner Design Report.

NC[6.17.2.10] The propeller and/or spinner design will not be accepted.

VV[6.17.2.10] Report evaluation.

R[6.17.2.11] The links of requirements R[6.17.2.7] and R[6.17.2.8] for the other serial numbers used in the competition must be sent to the Technical Committee up to 3 days before the start of the Competition.

NC[6.17.2.11] The use of serial numbers without video will not be accepted in the competition.

VV[6.17.2.11] Safety inspection.

R[6.17.2.12] The Propeller and/or Spinner Design Report must contain the considered flight envelope (maximum rotations supported by the propeller and/or spinner structure for each flight speed, from ZERO to the aircraft's maximum dive speed).

NC[6.17.2.12] The use of the propeller and/or spinner will not be authorized.

VV[6.17.2.12] Report evaluation.

R[6.17.2.13] The Propeller and/or Spinner Design Report must contain details demonstrating that the propeller and/or spinner design and construction are sufficiently safe.

NC[6.17.2.13] The use of the propeller and/or spinner will not be authorized.

VV[6.17.2.13] Report evaluation.

The team is responsible for verifying the aspects that must be analyzed and tested. This report will be verified by a safety judge and will not be part of the design score. If the judge's analysis concludes that the propeller in question is not safe, the propeller cannot be used during the competition.

6.18 Use of Explosive Material

R[6.18.0.1] No explosive material shall be used.

NC[6.18.0.1] Correction of non-conformity or the aircraft will be prohibited from flying.

VV[6.18.0.1] Safety inspection.

6.19 Control Surfaces

R[6.19.0.1] Control surfaces must not exhibit excessive play in their joints.

NC[6.19.0.1] Correction of non-conformity or the aircraft will be prohibited from flying.

VV[6.19.0.1] Safety inspection.

Control surfaces with play in their joints tend to reduce controllability in most cases and, in more severe cases, are flutter-inducing elements.

R[6.19.0.2] The number of joints (or hinge points) must be sized according to the wingspan and the loads acting on the surface.

NC[6.19.0.2] Correction of non-conformity or the aircraft will be prohibited from flying.

VV[6.19.0.2] Safety inspection.

R[6.19.0.3] Control surfaces must be securely attached to the aircraft.

NC[6.19.0.3] Correction of non-conformity or the aircraft will be prohibited from flying.

VV[6.19.0.3] Safety inspection.

It is not recommended that any control surface of the aircraft (ailerons, elevators, and rudder) be connected to the aircraft using only simple adhesive tape (of any type or thickness). Special tapes (with fiberglass reinforcement or similar) may be accepted, but the final decision on this matter will be made by the safety inspector and/or a member of the Technical Committee (yellow shirt).

6.20 Sizing and Selection of Actuator Servomotors

6.20.1 Actuator Servomotors Sizing

R[6.20.1.1] Analyses and/or tests must be presented in the **Aeroelasticity and Loads Report** and in the **Electrical Design and Safety Assessment Report** demonstrating that the servomotors used in the aircraft are properly sized and capable of withstanding, or overcoming with a certain margin, the aerodynamic loads to which the plane will be subjected during flight, as well as the landing and takeoff loads.

NC[6.20.1.1] Correction of non-conformity or the aircraft will be prohibited from flying.

VV[6.20.1.1] Report assessment.

R[6.20.1.2] The nominal voltage of the servomotors must be compatible with the battery voltage.

NC[6.20.1.2] Correction of non-conformity or the aircraft will be prohibited from flying.

VV[6.20.1.2] Report assessment and safety inspection.

6.20.2 Actuator Servomotors Originality

R[6.20.2.1] All actuator servomotors must be commercial.

NC[6.20.2.1] Correction of non-conformity or the aircraft will be prohibited from flying.

VV[6.20.2.1] Report assessment and safety inspection.

Examples of commercial servomotors: Hobbico, Futaba, JR, Tower Pro, GWS, etc.

R[6.20.2.2] Actuator servos must not be modified or have parts removed.

NC[6.20.2.2] The team will be penalized as described in **Appendix 7 Section 7.2** and correction of non-conformity or the aircraft will be prohibited from flying.

VV[6.20.2.2] Report assessment and safety inspection.

6.21 Wiring Requirements (Electronic Systems)

R[6.21.0.1] The wiring must be compatible with length and current (shown in the Report electrical diagram).

NC[6.21.0.1] Correction of non-conformity or the aircraft will be prohibited from flying.

VV[6.21.0.1] Report assessment and safety inspection.

In the case of extensions manufactured by the team, observe the following requirements (except for electric motor circuits).

R[6.21.0.2] All connections of the control system must be made with male/female connectors.

NC[6.21.0.2] Correction of non-conformity or the aircraft will be prohibited from flying.

VV[6.21.0.2] Safety inspection.

Note: If the aircraft has one or more electric motors, the use of soldering is allowed in its respective circuit in cases where male/female connection is not possible. In these specific cases, the use of appropriate safe insulation (for example, heat shrink tubing) is mandatory, as well as the description, in the technical report, of the soldering sizing and its respective manufacturing process. The use of soldering in the control circuit (receiver) is strictly prohibited. **Poor quality soldering or judged unsafe soldering may prevent aircraft from passing safety inspection.**

The recommended connectors are MODU with 3 pins or equivalent and the wires recommended for making servomotor/power extensions are AWG 24 to 28 non-rigid, filamented with parallel wires and colorful (flat cable rainbow).

R[6.21.0.3] "Bare wire" and/or enameled insulation wires must not be used.

NC[6.21.0.3] Correction of non-conformity or the aircraft will be prohibited from flying.

VV[6.21.0.3] Safety inspection.

6.22 Video of a Landing and Weighing (mandatory) and other flight phases (bonus)

The main purpose of the video of a flight is to demonstrate that the designed aircraft is capable of flying in a stable and controllable manner. In the Regular Class, it is **NOT** mandatory for flight videos to be recorded flying over the obstacle at the end of takeoff. For the Micro Class, it **IS** mandatory for takeoff to be made using a platform with the same dimensions defined in R[9.2.4.2].

R[6.22.0.1] The team must post an video of an accident-free flight of the aircraft on the website www.youtube.com, and must indicate on the website www.aerocf.com.br the link to the video.

NC[6.22.0.1] Aircraft prohibited from flying in the competition.

VV[6.22.0.1] Video of a flight assessment.

The submission of the video grants the team a bonus of 30 points.

R[6.22.0.2] The video of a flight must show the takeoff of the aircraft.

NC[6.22.0.2] Penalty of 10 points.

VV[6.22.0.2] Video of a flight assessment.

R[6.22.0.3] The aircraft must demonstrate being safe, maneuverable, and stable throughout the flight.

NC[6.22.0.3] The Technical Committee may request a new video requiring specific maneuvers (not counting towards the score and with a delivery date to be specified case by case) and/or the aircraft may be prohibited from flying in the competition.

VV[6.22.0.3] Video of a flight assessment.

For requirement **R[6.22.0.3]**, special attention will be given to unconventional configurations.

R[6.22.0.4] The video of a flight must show a landing (touchdown and beginning of the roll) within the designated landing zone area.

NC[6.22.0.4] Aircraft prohibited from flying in the competition.

VV[6.22.0.4] Video of a flight assessment.

“Rough” landings, off the runway, or clearly uncontrolled and intentionally performed by the pilot will be considered **crashes**, invalidating the flight. If there is no paved runway that clearly marks its direction and position, takeoff and landing must be performed in the same direction and path and in a visibly similar region.

Crashes are not considered landings. The only items whose damage does not invalidate the video are the landing gear and propeller.

R[6.22.0.5] The landing gear must not suffer breakage or permanent deformation.

NC[6.22.0.5] Penalty of 30 points.

VV[6.22.0.5] Video of a flight assessment.

R[6.22.0.6] The flight must be performed with at least the minimum payload required for a valid flight (as described in section 10.2.1)

NC[6.22.0.6] Aircraft prohibited from flying in the competition.

VV[6.22.0.6] Video of a flight assessment.

R[6.22.0.7] The video of a flight must clearly show the loaded cargo (must be visible and readable in the video), in order to demonstrate compliance with requirement R[6.22.0.6].

NC[6.22.0.7] Aircraft prohibited from flying in the competition.

VV[6.22.0.7] Video of a flight assessment. Weighing of TOW (airplane + cargo) followed by weighing of the empty aircraft for calculation of the cargo weight will not be accepted for all Classes, only direct weighing of the cargo.

R[6.22.0.8] For Micro Class, the video of a flight must show takeoff from the platform defined in R[9.2.4.2], with the only external interference allowed on the aircraft being a team member holding the aircraft, if the team deems it necessary, as described in R[9.2.4.1].

NC[6.22.0.8] Aircraft prohibited from flying in the competition.

VV[6.22.0.8] Video of a flight assessment.

R[6.22.0.9] For Micro Class, the length, width, and height relative to the ground of the takeoff platform must be demonstrated in the video. The dimensions must be within a margin of $\pm 5\%$ in relation to what is defined in R[9.2.4.2].

NC[6.22.0.9] Penalty of 10 points.

VV[6.22.0.9] Video of a flight assessment.

It is strongly recommended that:

- a “bathroom scale” not be used. These scales have a minimum load higher than the MTOWs of AeroDesign aircraft, so their use may invalidate weighing;
- the team waits until the scale settles on the value. Oscillating values make it very difficult to visualize the measured weight and may invalidate weighing;
- it is demonstrated that the scale is calibrated.

R[6.22.0.10] The flight video must have continuous (uncut) footage with the aircraft visible between takeoff and landing.

NC[6.22.0.10] Penalty of 10 points.

VV[6.22.0.10] Video of a flight assessment.

R[6.22.0.11] The video must have continuous (uncut) footage with the aircraft visible between landing and weighing to ensure that the weighing corresponds to the flight.

NC[6.22.0.11] Aircraft prohibited from flying in the competition.

VV[6.22.0.11] Video of a flight assessment.

In case of defocusing, which sometimes occurs due to the autofocus of some cameras, or loss of the aircraft or cargo for a period due to the lack of skill of the cameraperson, the video may be accepted if it is found that there was no attempt to tamper with the footage. It is highly recommended to use a high-quality camera mounted on a tripod or monopod operated by an experienced cameraperson.

R[6.22.0.12] The flight video must be submitted by the date specified in the **Appendix 9**.

NC[6.22.0.12] A penalty will be applied according to the **Appendix 7 Section 7.5** if the video is posted by the deadline with a penalty (see **Appendix 9**) or the aircraft will be prohibited from flying if the video is posted after the deadline with a penalty.

VV[6.22.0.12] Video of a flight assessment. For penalty purposes, the date to be counted is the posting of the link on the website www.aeroct.com.br.

The video of a flight score will not be lower than 0 (zero) points even if the penalties add up to more than 30 points.

The Technical Committee will release a preliminary list of approved videos of a flight by the date specified in the **Appendix 9**, which is before the final date for video submission. Teams will then have the opportunity to resubmit a video if the first one is rejected as specified in **NC[6.22.0.3]**. Videos submitted after this preliminary release date will only be officially released after the maximum penalty submission date (see **Appendix 9**).

Therefore, it is in the team's interest to submit the videos as soon as possible so that there is time to remake the video if necessary. Videos submitted close to the deadline that are considered invalid may not receive feedback in a timely manner, and the team may be prohibited from participating in the competition, receiving the news close to the competition. There will be no possibility of submitting a new video after the maximum penalty submission date (see **Appendix 9**).

R[6.22.0.13] The flight video must be public on youtube, so that other teams can watch it.

NC[6.22.0.13] Team will be requested to change the video's viewing permissions.

VV[6.22.0.13] Video of a flight assessment.

R[6.22.0.14] The audio of the flight video must be kept original.

NC[6.22.0.14] Penalty of 5 points on the video.

VV[6.22.0.14] Video of a flight assessment.

The addition of music may cause copyright issues. In the past, there have been videos from teams that were removed, causing inconvenience for the Technical Committee and the team. Additionally, listening to the propellers aids in the video evaluation. The Technical Committee understands the team's joy in achieving project objectives and exalted celebrations will not influence the video evaluation even if they contain swearing and foul language.

R[6.22.0.15] The maximum duration of the flight video must be 4 minutes (Regular and Advanced Class) and 5 minutes (Micro Class).

NC[6.22.0.15] Penalty of 0.1 points for each second exceeding the limit.

VV[6.22.0.15] Video of a flight assessment.

This time limit is sufficient for the flight and weighing. However, it is necessary for the team and the aircraft to be prepared for the video shoot, without adjusting scales, payload, plane, etc., during the video.

The speed of parts of the video is allowed to be altered, when the aircraft is not in flight, provided that this does not compromise the understanding of key points of the video.

In exceptional cases, when the invalidation of the flight is considered “marginal”, i.e., the team was very close to validation but invalidated due to some small issue, the Technical Committee may decide to authorize the team to fly in the competition by zeroing the Flight Video Bonus. Example: the aircraft is in excellent flight condition but crashed due to an obvious pilot error, but it was still possible to weigh the payload. These situations will be evaluated case by case, and the decision of the Technical Committee will be final and unquestionable.

7. Requirements - Regular Class

7.1 Eligibility - Team Members

- R[7.1.0.1]** Students must be undergraduate students in Engineering, Physics, and Technologies related to mobility.
- NC[7.1.0.1]** Registration not accepted.
- VV[7.1.0.1]** Member registration process.
-
- R[7.1.0.2]** Students must submit proof of enrollment for the second semester of 2024 by the deadline specified in **Appendix 9**.
- NC[7.1.0.2]** Registration not accepted.
- VV[7.1.0.2]** Member registration process.

Refer to the rules of Section 6.1.

7.2 Physical Restrictions

With the aim of bringing the technical challenge of the competition closer to the reality of the aeronautical industry, a restriction has been estimated that makes an analogy with the approximate “cost” for the development and manufacturing of a new aircraft. The equation for the restriction combines the power of the electric motor, wingspan, and number of longitudinal lifting surfaces as presented in **R[7.2.0.1]**. The challenge for each team will be to find the combination of these parameters that leads to an aircraft with high payload capacity obeying the approximate “cost” restriction and other physical restrictions.

- R[7.2.0.1]** The aircraft, by design, must comply with the following physical restrictions based on geometric dimensions and maximum power measured in flight:

$$\begin{aligned} P \cdot B^{0.1529+0.1233 \cdot \max(N,2)} &\leq 981.8 \\ H &\leq 0.6\text{m} \\ B &\leq 2.5\text{m} \\ P &\leq 850\text{W} \end{aligned} \tag{7.1}$$

Definition of parameters as follows:

- H* - height of the aircraft, measured from the ground to the highest point of the aircraft;
- B* - maximum wingspan, greatest length between the extremities of the aircraft, on the axis perpendicular to the flight axis;
- P* - maximum power of the electric motor measured in flight;
- N* - number of main lifting surfaces exerting longitudinal function (e.g., wing, conventional horizontal tail, V-tail, etc.)

The design values of H , B , P , and N chosen by the team must be informed on the official website respecting the report submission dates.

NC[7.2.0.1] Correction of non-compliance, penalized for project alteration according to **Section 6.9**, or the aircraft will be prevented from flying.

VV[7.2.0.1] Evaluation of data sent on the official website.

R[7.2.0.2] The aircraft, in post-flight measurement configuration, must comply with the design values for H , B , P , and N chosen by the team.

NC[7.2.0.2] Penalty as follows:

Equation for geometric deviation ΔS_d in meters:

$$\Delta S_d = \max(0, (H_{\text{Measured}} - 0.6), (B_{\text{Measured}} - B_{\text{Design}}))$$

If Deviation $\leq 0.050m$ then $P_D = 100 \cdot \Delta S_d$

If Deviation $> 0.050m$, the flight is invalid or the team can choose an additional penalty added to the previous one according to **Appendix 7, Section 7.2**.

Equation for excess power ΔS_p in Watts:

$$\Delta S_p = \max(0, (P_{\text{Measured}} - P_{\text{Design}}))$$

$$P_P = 0.5 \cdot \Delta S_p$$

Where P_D is the penalty for exceeding the dimensional limit and P_P is the penalty for exceeding the maximum design power. The penalties P_D and P_P above are calculated for each test battery and are not cumulative.

VV[7.2.0.2] Post-flight inspection. Power verification will be done through a Wattmeter installed in the aircraft, and the peak power during flight will be considered.

Aircraft of the Regular Class will be considered in measurement configuration when fully assembled and with:

- Cargo compartment empty and closed,
- Propeller positioned in the condition that results in the highest height,
- Control surfaces not deflected (ailerons, rudders, elevator, spoilers, aerodynamic brakes),
- Flaps and slats in the retracted position,
- Any other movable and/or articulated devices in the position that results in the worst measurement of this dimensional requirement,
- Aircraft on the ground in the same position as at the beginning of takeoff, whether for tricycle or conventional landing gear. The use of small wheel chocks (reference value of up to 5 mm thick) to correct ground unevenness will be allowed. The team must provide the chocks for measurement.

R[7.2.0.3] The mandatory Three-View drawing (**Section 11.4.1** and **Appendix 5**) must contain the dimensions to demonstrate compliance with **R[7.2.0.1]**.

NC[7.2.0.3] Penalties applied according to **Appendix 7**.

VV[7.2.0.3] Report evaluation.

7.3 Motor

7.3.1 Electric Motor

- R[7.3.1.1]** The aircraft must be single-engine and have an electric motor propulsion system with maximum design power that meets **R[7.2.0.1]**.
- NC[7.3.1.1]** If inconsistency is identified in the design values, the team must correct the non-compliance, being penalized for project alteration according to **Section 6.9**, or the aircraft will be prevented from flying. Regarding the peak power measured in flight, if the measured value exceeds the design value, the penalty will be according to **R[7.2.0.1]**.
- VV[7.3.1.1]** Report evaluation and post-flight. Post-flight verification will be done through a Wattmeter installed in the aircraft, and the peak power during flight will be considered.

- R[7.3.1.2]** The motor must be commercial.
- NC[7.3.1.2]** Aircraft prevented from participating in the competition.
- VV[7.3.1.2]** Submission of documents, report evaluation, and safety inspection.

The team can limit the power through radio settings if desired.
The permitted wattmeters are:

- FT08 RC - Watt Meter 150A
- FT08 RC - Watt Meter 200A
- Turnigy 130A Watt Meter and Power Analyzer
- Turnigy 180A Watt Meter and Power Analyzer
- GT Power 130A Watt Meter and Power Analyzer
- GT Power 150A Watt Meter and Power Analyzer
- GT Power 180A Watt Meter and Power Analyzer

- R[7.3.1.3]** The aircraft must have a commercial wattmeter (chosen from the list above), capable of recording peak power, installed and easily visible.
- NC[7.3.1.3]** Non-compliance correction or the aircraft will be grounded.
- VV[7.3.1.3]** Safety inspection.

- R[7.3.1.4]** The wattmeter must be installed as shown in the figure below:



Figura 7.1: Example of how the wattmeter should be installed.

- NC[7.3.1.4]** Non-compliance correction or the aircraft will be grounded.
- VV[7.3.1.4]** Safety inspection.

- R[7.3.1.5]** The peak power must be easily verifiable after the flight, without the need to move the wattmeter or remove parts of the aircraft. The team must not turn off the wattmeter before the peak power reading by the referee.
- NC[7.3.1.5]** Penalty according to **Appendix 7, Section 7.3.**
- VV[7.3.1.5]** Post-flight inspection.

The **R[7.3.1.4]** is intended to ensure that disconnecting the motor without turning off the wattmeter is possible, thus ensuring compliance with requirement **R[7.3.1.5]**. If the team chooses to place an arm plug or on/off switch between the battery and Wattmeter to preserve the battery before the flight, it is allowed, but the team must be aware that turning it off after the flight will result in data loss and penalty according to **R[7.3.1.5]**.

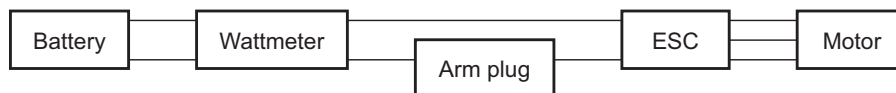
It is the team's responsibility to ensure that the wattmeter does not turn off before the peak power reading by the referee.

- R[7.3.1.6]** The documentation of the chosen motor and battery manufacturer indicating their characteristics must be sent on the website www.aerocf.com.br, together with the Report.
- NC[7.3.1.6]** Aircraft prevented from participating in the competition.
- VV[7.3.1.6]** Submission of documents and report evaluation.

The weight of the wattmeter, ESC, and propulsion system battery will be considered as the Empty Weight of the aircraft.

- R[7.3.1.7]** The Electronic Speed Controller (ESC) must be commercial.
- NC[7.3.1.7]** Aircraft prevented from participating in the competition.
- VV[7.3.1.7]** Evaluation of report and safety inspection.

- R[7.3.1.8]** The motor battery must not deplete during flight, similar to a fuel exhaustion.
- NC[7.3.1.8]** Flight invalidated.
- VV[7.3.1.8]** Post-flight inspection.

7.3.2 Motor Mounting on the Aircraft

It is recommended that the motor be mounted conventionally, that is, as recommended by the manual. Different fasteners may be accepted provided they are planned, calculated, and tested in the team's report. A detailed evaluation of non-conventional fasteners may eventually be required.

7.3.3 Transmission Boxes, Belts, and Propeller Shafts

- R[7.3.3.1]** Transmission boxes, belts, and propeller shafts are allowed, but must have a one-to-one rotation ratio between motor and propeller.
- NC[7.3.3.1]** Correction of non-compliance, penalized by project alteration or the aircraft will be prevented from flying.
- VV[7.3.3.1]** Evaluation of report and safety inspection.

7.4 Cargo and Cargo Compartment

7.4.1 Cargo Compartment (Geometric Restrictions)

The cargo compartment can be designed with the dimensions desired by the team.

- R[7.4.1.1] The cargo compartment must be single.
- NC[7.4.1.1] Correction of non-compliance, penalized by project alteration or the aircraft will be prevented from flying.
- VV[7.4.1.1] Safety inspection.

- R[7.4.1.2] The cargo compartment must be fully closed, with cargo access doors that must be part of the airplane.
- NC[7.4.1.2] If verified before flight: correction of non-compliance, penalized by project alteration or the aircraft will be prevented from flying. If verified after flight: flight invalidated.
- VV[7.4.1.2] Safety inspection and post-flight inspection.

Explaining further the rule **R[7.4.1.2]**, the airflow must not come into contact with the cargo or cargo support, meaning that any geometry defining the aerodynamic shape of the aircraft must be part of the aircraft, counting as the empty weight of the aircraft, not as payload. If, at the time of weighing, it is found that the payload (all the cargo to be weighed, i.e., cargo and cargo support) has external components, the flight will be invalidated, and the team can make the necessary changes subject to penalties according to **Section 6.9** regarding project changes.

7.4.2 Payload

Payload is the weight carried by the aircraft. The total payload consists of the sum of the weights of the plates (or cargo) plus the cargo support. The weight of the aircraft and the batteries of the propulsion system together with the wattmeter and ESC are NOT considered payload (See **Appendix 1**).

- R[7.4.2.1] The payload must not contain lead parts.
- NC[7.4.2.1] Non-compliance correction or the aircraft will be grounded.
- VV[7.4.2.1] Safety inspection.

- R[7.4.2.2] The aircraft must not have ballast or any other lead parts.
- NC[7.4.2.2] Non-compliance correction or the aircraft will be grounded.
- VV[7.4.2.2] Safety inspection.

- R[7.4.2.3] All payload must be contained in a single cargo compartment, as per **Subsection 7.4.1**.
- NC[7.4.2.3] Non-compliance correction or the aircraft will be grounded.
- VV[7.4.2.3] Safety inspection.

- R[7.4.2.4] The payload must be a single assembled unit.
NC[7.4.2.4] Non-compliance correction or the aircraft will be grounded.
VV[7.4.2.4] Safety inspection.

- R[7.4.2.5] The payload structure must consist only of rigid elements. The geometry of the payload cannot be variable.
NC[7.4.2.5] Non-compliance correction or the aircraft will be grounded.
VV[7.4.2.5] Safety inspection.

It is suggested to assemble the payload as the combination of a “cargo support” plus the “cargo plates” (see example in **Appendix 1**).

- R[7.4.2.6] The support + payload set must be equal to or less than the volume of the compartment specified in **Subsection 7.4.1**.
NC[7.4.2.6] Non-compliance correction or the aircraft will be grounded.
VV[7.4.2.6] Safety inspection.

If specified by the team, the payload can be positioned inside the compartment with excess space, allowing the adjustment the aircraft’s CG.

- R[7.4.2.7] The payload must be adequately secured in the cargo compartment (see **Section 6.15**) to prevent its movement during flight.
NC[7.4.2.7] Non-compliance correction or the aircraft will be grounded.
VV[7.4.2.7] Evaluation of report and safety inspection.

- R[7.4.2.8] The payload must not structurally contribute to the stability of the aircraft structure or be part of it.
NC[7.4.2.8] Correction of non-compliance, penalized by project alteration or the aircraft will be prevented from flying.
VV[7.4.2.8] Evaluation of report and safety inspection.

In other words, structures whose stability is aided by contact with the cargo support or the cargo will not be accepted. Examples:

- Structures where attaching the cargo support on any face of the cargo compartment enables this cargo support to aid in structural stability. In principle, the structure must be stable and withstand flight loads by itself, i.e., even without the cargo support.
- Structures where simply placing the payload (or cargo support) allows designing a structure with fewer truss bars, i.e., it is not allowed for structural loads that should normally be transmitted by the aircraft structure to be applied and transmitted by the cargo support.
- Other cases, even if not mentioned in these examples, in which the Technical Committee judges that the cargo support or the payload is contributing to support the loads or is contributing to the stability of the structure, will be evaluated on a case-by-case basis.

The locking mechanism of the cargo support on the aircraft can be part of the cargo support being weighed as payload or of the aircraft structure and then be counted as empty weight.

- R[7.4.2.9] The cargo access door opening device must be part of the aircraft, not the payload, and the door (or fairing) cannot be locked or attached to the cargo support, only to the aircraft structure.
- NC[7.4.2.9] Correction of non-compliance, penalized by project alteration or the aircraft will be prevented from flying.
- VV[7.4.2.9] Evaluation of report and safety inspection.

It is the responsibility of the teams to provide their own payload. The weight check will be performed after flight in the presence of the officials. The aircraft that does not allow the removal of the support for weighing will not have this weight included in the payload.

- R[7.4.2.10] The payload can only be removed for weighing in the post-flight inspection tent in the presence of an official.
- NC[7.4.2.10] Flight invalidated.
- VV[7.4.2.10] Post-flight inspection.

7.5 Electronics

7.5.1 Flight Control System Battery Pack

- R[7.5.1.1] The flight control system battery pack must have a minimum of 500 mAh.
- NC[7.5.1.1] Non-compliance correction or the aircraft will be grounded.
- VV[7.5.1.1] Evaluation of report and safety inspection.

Additionally, all general requirements regarding batteries from **Section 6.12** must be met.

7.5.2 Propulsion System Battery Pack

- R[7.5.2.1] The propulsion system battery pack must have a minimum of 3000 mAh.
- NC[7.5.2.1] Non-compliance correction or the aircraft will be grounded.
- VV[7.5.2.1] Evaluation of report and safety inspection.

- R[7.5.2.2] The set of batteries powering the propulsion system must have an equivalent voltage of at least 4 cells (4S) and a maximum of 6 cells (6S).
- NC[7.5.2.2] Non-compliance correction or the aircraft will be grounded.
- VV[7.5.2.2] Evaluation of report and safety inspection.

- R[7.5.2.3] The propulsion system battery pack must have a discharge rate of at least 20C.

NC[7.5.2.3] Non-compliance correction or the aircraft will be grounded.

VV[7.5.2.3] Evaluation of report and safety inspection.

R[7.5.2.4] It must be possible to verify the battery characteristics.

NC[7.5.2.4] Non-compliance correction or the aircraft will be grounded. For this requirement, it is required that the original adhesive with the battery characteristics be maintained.

VV[7.5.2.4] Evaluation of report and safety inspection.

Additionally, all general requirements regarding batteries from **Section 6.12** must be met.

7.5.3 Flight Control Systems

R[7.5.3.1] The aircraft must not utilize gyroscopes and/or automatic flight control systems of any kind.

NC[7.5.3.1] Correction of non-compliance, penalized by project alteration according to **Section 6.9** or the aircraft will be prevented from flying.

VV[7.5.3.1] Evaluation of report and safety inspection.

7.6 Maximum Takeoff Weight - Regular Class

R[7.6.0.1] The total weight of the aircraft (empty weight + payload) must not exceed **20 kg**.

NC[7.6.0.1] The payload will be considered as the difference between 20kg and the empty weight. The excess payload will not be considered.

VV[7.6.0.1] Post-flight inspection.

7.7 Scoring - Regular Class

The score of each battery is the sum of the scores P_{FLIGHT} and P_{AC} (described in **Sections 7.7.4** and **7.7.5**) and the bonuses B_{PO} , B_{RC} , and B_{CF} (described in **Sections 7.7.6**, **7.7.7** and **7.7.8**) as applicable, and subtracted by penalties, if any, for dimensional accuracy P_D and excess of power P_P (**Section 7.2**).

The accounting of other penalties such as side excursion (**Section 10.1.8**), and cumulative penalties, among others (**Appendix 7**), will be done in the final computation of the team's score.

7.7.1 Maximum Payload [per flight battery]

For each valid flight (see **Subsection 10.1.9**), a score proportional to the carried payload will be computed as follows:

$$P_{CP} = 12.5 \times CP \quad (7.2)$$

Where P_{CP} Points obtained due to carried payload; CP Total Carried Payload (in kg).

7.7.2 Empty Weight Prediction [per flight battery]

With the intention of encouraging teams to improve their engineering processes and to build and thoroughly test their official aircraft well in advance of the Competition, a factor called Empty Weight Prediction Factor (FPV) has been inserted, calculated by the following formula:

$$FPV = 1.10 - 15 \times \left(\frac{PV_{EXPECTED} - PV_{EXECUTED}}{PV_{EXPECTED}} \right)^2 \quad (7.3)$$

The minimum value of FPV is 0.80. If the calculated FPV for the team is lower than this value, the minimum FPV will be used.

- R[7.7.2.1] The expected empty weight must be presented on the website www.aerocf.com.br.
- NC[7.7.2.1] The minimum FPV will be automatically applied.
- VV[7.7.2.1] Document submission and report evaluation.

It is suggested that this value also be clearly presented in the Design Report and Three-View Technical Drawing.

7.7.3 Report Score Factor [per flight battery]

With the intention of stimulating teams to pay more attention to the quality of their report, a factor called Report Score Factor (FPR) has been inserted, calculated by the following formula:

$$FPR = \min \left(1.00 ; 0.50 + 0.75 \times \frac{NR}{NR_{max}} \right) \quad (7.4)$$

Where NR is the total report score of the team, as per **Section 11.1**; NR_{max} maximum report score (185 points), as per **Section 11.1**.

7.7.4 Flight Score [per flight battery]

The flight score of each test battery will be calculated according to the following formula:

$$P_{VOO} = FPV \times FPR \times P_{CP} \quad (7.5)$$

With P_{CP} , FPV , and FPR defined in Sections 7.7.1, 7.7.2, and 7.7.3, respectively.

7.7.5 “Accuracy” of Payload [per flight battery]

Additional points will be added based on the accuracy of the payload capacity prediction. The resulting score of this “accuracy” is calculated by the following formula:

$$P_{AC} = 30 - 830 \times \text{abs} \left(\frac{CP_{EXPECTED} - CP_{EXECUTED}}{CP_{EXPECTED}} \right)^{1.75} \quad (7.6)$$

as long as the expression has a positive value. Otherwise, the score will be zero (0).

Where: P_{AC} Accuracy score; $CP_{EXPECTED}$ Expected payload (obtained from the payload capacity graph - Section 11.5); $CP_{EXECUTED}$ Actual payload (obtained in flight) - Subsection 7.7.1.

7.7.6 Landing Distance [per flight battery]

- R[7.7.6.1]** The aircraft must come to a complete stop after landing within the delimited runway area in requirement **R[10.1.8.1]**.
- NC[7.7.6.1]** The team does not gain landing bonus.
- VV[7.7.6.1]** Procedures performed on the runway. There will be marked lines delimiting the runway boundaries and referees.

Teams that perform a valid flight (see Section 10.1.10), and comply with requirement **R[7.7.6.1]**, will receive a bonus as follows:

$$B_{PO} = 1.0 \times CP \quad (7.7)$$

Where B_{PO} are the points obtained as a bonus for stopping within the specified distance; CP is the Payload (kg), as per Subsection 7.7.1.

Only the points related to the best battery will be considered in the final score obtained by the team. This bonus will not be cumulative.

7.7.7 Cargo Removal Time [per flight battery]

The opening of the cargo compartment after each valid flight will be timed, and bonus points will be given to teams that can complete the operation (i.e., open the cargo compartment and remove all payload) within a maximum time, following the bonus rule below:

$$B_{RC} = \min \left(20 ; 40 - \frac{t}{3} \right) \text{ if } t < 120 \text{ seconds} \quad (7.8)$$

Where B_{RC} is the bonus for cargo removal time; t is the time to remove cargo, timed in seconds.

The score will be applied as long as the expression has a positive value. If the cargo is not removed within the maximum time of **Equação 7.8**, the bonus will be zero (0).

- R[7.7.7.1]** Cargo removal must be completed within a maximum time of 10 minutes.
- NC[7.7.7.1]** Invalid flight.
- VV[7.7.7.1]** Post-flight inspection.

- R[7.7.7.2]** Up to two team members can perform cargo removal.
- NC[7.7.7.2]** The team does not receive the cargo removal time bonus.
- VV[7.7.7.2]** Post-flight inspection.

- R[7.7.7.3]** No cutting tool should be used during cargo removal to cut the lid or any other component of the aircraft.
- NC[7.7.7.3]** The team does not receive the cargo removal time bonus.
- VV[7.7.7.3]** Post-flight inspection.

R[7.7.7.4] Every piece or component of the cargo compartment must be suitable for reuse after cargo removal.

NC[7.7.7.4] The team does not receive the cargo removal time bonus.

VV[7.7.7.4] Post-flight inspection.

R[7.7.7.5] Adhesive and/or sticky elements may be used as covering, but **must not** be used as a cargo compartment door closure mechanism, **nor contribute in any way to the closure.**

NC[7.7.7.5] The team does not receive the cargo removal time bonus.

VV[7.7.7.5] Post-flight inspection.

By the rules R[7.7.7.4] and R[7.7.7.5], it is understood that no component may be destroyed upon opening, even if inadvertently. Cargo compartment closure systems must be such that they can be reused without having their characteristics modified.

Adhesive tapes or any other adhesive components cannot be reused, therefore their use as a cargo compartment cover or as a door closure mechanism causes the team to lose the right to the bonus. The tape should also not be used for aerodynamic closure, i.e., used to close gaps between the door and the aircraft structure. The team should adopt other non-adhesive solutions for door closure.

It is not necessary to remove the cargo from the cargo support, i.e., the cargo removal timer will be stopped after the removal of the cargo and cargo support assembly from the aircraft cargo compartment.

7.7.8 Reliability Bonus [single bonus]

In order to benefit teams whose design has great reliability and manages to make more than one flight with a significant payload, the following bonus will be awarded:

$$B_{CF} = 20 \times \left[1 - \left(5 \times \frac{P_{B1} - P_{B2}}{P_{B1}} \right)^2 \right] \quad (7.9)$$

Provided that the expression has a positive value. Otherwise, the score will be zero (0). Where P_{B1} is the total score of the best test battery; P_{B2} is the total score of the second-best test battery.

7.8 Valid Takeoff

R[7.8.0.1] The aircraft must take off and fly over an obstacle **70 cm high and 10m wide** positioned **55 m from the start of the takeoff run**, at the end of the official runway.

NC[7.8.0.1] Flight invalidated or penalty according to R[7.8.0.4] and NC[7.8.0.4].

VV[7.8.0.1] Runway. There will be a obstacle clearance verification by officials, with the main landing gear as a reference point for visual verification.



Figura 7.2: Valid Regular Class Takeoff: obstacle.

The device designed to emulate the takeoff obstacle is detailed in **Appendix 11**. There will be a device at each end of the runway to allow takeoff in the direction defined by the runway judge. Auxiliary markings on the runway from 40 to 55 meters away, spaced 5 meters apart, will be available to provide visual feedback to the pilot and thus allow the decision to rotate the aircraft at the point defined by the team. The tape has its striped face upwards (**Appendix 11**).

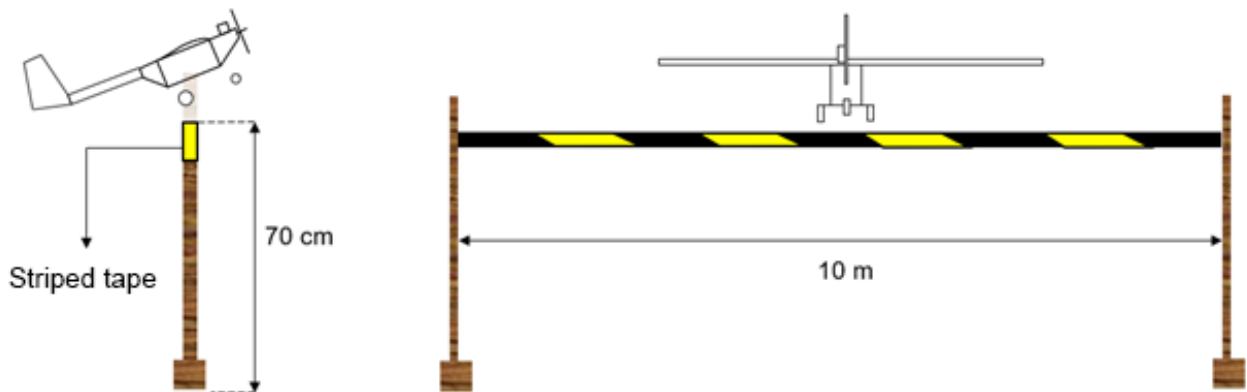

Figura 7.3: Valid Regular Class Takeoff: runway with obstacle.

The end of the takeoff runway, marked by the obstacle, will be supervised by a runway official, as illustrated in the following figure.

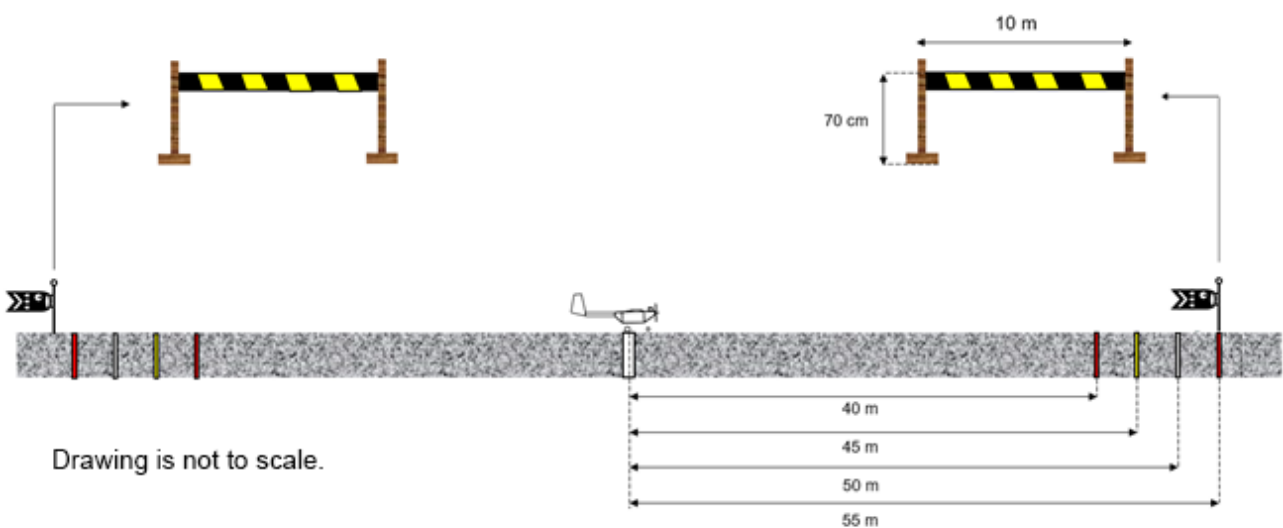

Figura 7.4: Valid Regular Class Takeoff.

- R[7.8.0.2] The obstacle (supports and tape) must not suffer damage during takeoff.
- NC[7.8.0.2] Subject to penalty or flight invalidation according to judgment, case by case, by the Technical Committee and Runway Judge.
- VV[7.8.0.2] Verification by the runway judge.

Touching the tape does not necessarily invalidate the flight if it remains intact, but its complete rupture invalidates the takeoff according to R[7.8.0.3].

- R[7.8.0.3] The obstacle tape must not suffer damage leading to total rupture during takeoff.
- NC[7.8.0.3] Flight invalidated.
- VV[7.8.0.3] Verification by the runway judge.

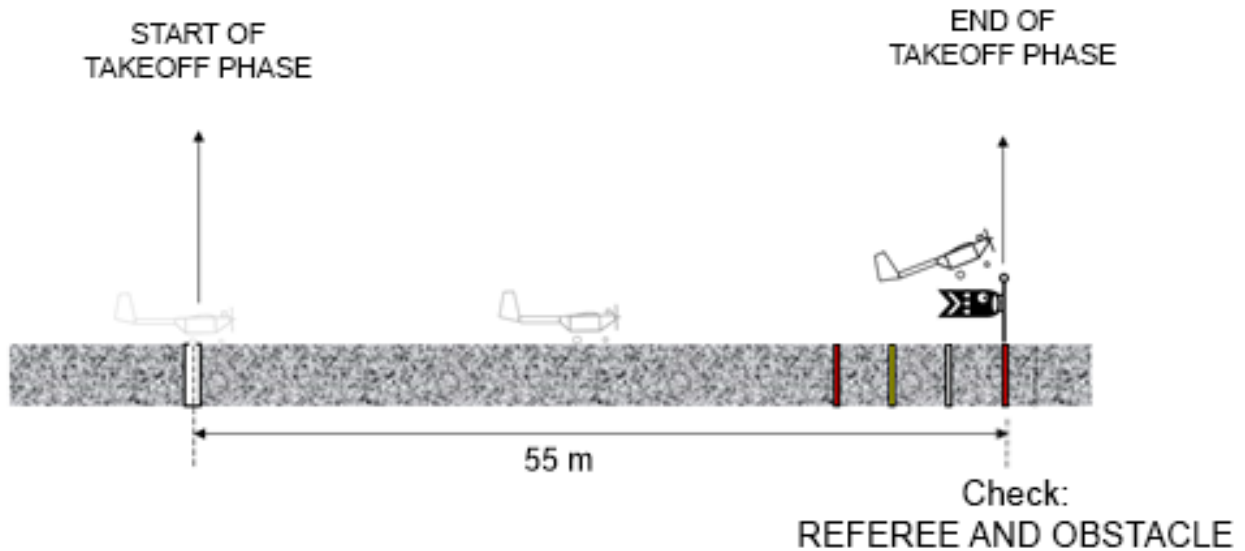
Flight invalidation in cases where the aircraft collides and damages the obstacle without tape rupture will be evaluated on a case-by-case basis by the Runway Judge and Technical Committee. Total attention will be given to ensure that the same criterion is adopted for all teams.

- R[7.8.0.4] The aircraft must fly over the obstacle respecting its width.
- NC[7.8.0.4] Penalty according to **Appendix 7, Section 7.3**.
- VV[7.8.0.4] Verification by the runway judge and officials. The main landing gear will be the reference point for verification and must be laterally contained within the obstacle width.



Figura 7.5: Invalid and valid takeoff with applicable penalty Regular Class.

The striped tape, not being a rigid component, is subject to deformation due to wind. The tape will be the reference for flight validation regardless of deformation.

In case of collision with the takeoff obstacle, the aircraft is also subject to structural integrity requirements according to **Subsection 10.1.10**.

Additionally, takeoff is subject to the requirements of **Subsection 10.1.6**.

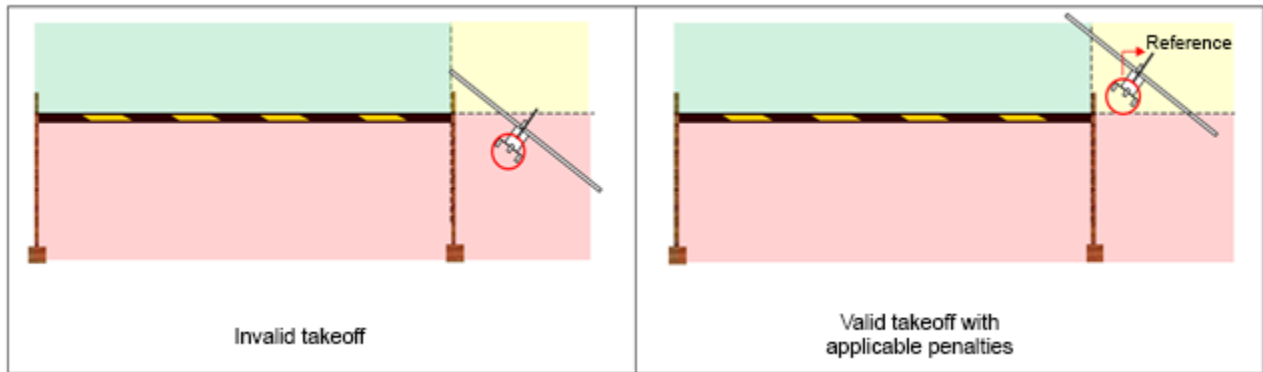
8. Requirements - Advanced Class

8.1 Eligibility - Team Members

- R[8.1.0.1] Students must be undergraduate or graduate (*stricto sensu*) students in Engineering, Physics, and Technologies related to mobility.
- NC[8.1.0.1] Registration not accepted.
- VV[8.1.0.1] Members registration process.
-
- R[8.1.0.2] Students must submit proof of enrollment for the second academic semester of 2024 (both undergraduate and graduate students) by the date stipulated in **Appendix 9**.
- NC[8.1.0.2] Registration not accepted.
- VV[8.1.0.2] Members registration process.

Please pay attention to the requirements in Section 6.1.

8.2 Motor

- R[8.2.0.1] Only electric motors must be used.
- NC[8.2.0.1] Correction of non-compliance, penalized by project changes as per Section 6.9 or the aircraft will be prevented from flying.
- VV[8.2.0.1] Evaluation of report and safety inspection.
-
- There is no limitation regarding the number of motors.
- R[8.2.0.2] Manufacturer documentation of the chosen motor(s) indicating its characteristics must be submitted on the website www.aeroct.com.br, along with the Report.
- NC[8.2.0.2] Aircraft prevented from participating in the competition.
- VV[8.2.0.2] Submission of documents and report evaluation.
-
- R[8.2.0.3] A descriptive report about any modifications made to the motor must be submitted on the website www.aeroct.com.br, along with the Report.
- NC[8.2.0.3] Aircraft prevented from participating in the competition.
- VV[8.2.0.3] Submission of documents and report evaluation.
-
- R[8.2.0.4] Technical documentation describing the batteries of the propulsion, control, and on-board systems must be submitted on the website www.aeroct.com.br, along with the Report.
- NC[8.2.0.4] Aircraft prevented from participating in the competition.
- VV[8.2.0.4] Submission of documents and report evaluation.

8.2.1 Transmission Boxes, Belts, and Propeller Shafts

Transmission boxes, belts, and propeller shafts are allowed. The rotation ratio between motor and propeller can be different from one to one.

8.3 Propulsion System Battery

R[8.3.0.1] Electric motors must have a battery pack completely separated from other electronic components.

NC[8.3.0.1] Non-compliance correction or the aircraft will be grounded.

VV[8.3.0.1] Safety inspection.

R[8.3.0.2] The motor battery must not deplete during flight, similar to a fuel exhaustion.

NC[8.3.0.2] Flight invalidated.

VV[8.3.0.2] Post-flight inspection.

The propulsion system battery, which must be used solely for powering the electric motors, can be installed in the aircraft in two ways:

- Being part of the aircraft, not needing to be removed from the aircraft after flight, and being counted as empty weight of the aircraft; or
- Being part of the payload (up to 1 kg, above that, the excess will be considered empty weight), being counted and weighed together with the payload.

R[8.3.0.3] For the battery to be considered payload, it must be in a separate cargo compartment from the main payload (Subsection 8.9.1).

NC[8.3.0.3] The battery will be completely considered part of the empty weight of the aircraft.

VV[8.3.0.3] Post-flight inspection.

This measure is for safety, so that the battery is not damaged in the quick removal procedure of the payload (Subsection 8.10.6).

R[8.3.0.4] The battery removal process for weighing must be possible to be carried out, without damaging the battery, within a time of up to 10 minutes (reference value to ensure the smooth running of the competition).

NC[8.3.0.4] The battery will be completely considered part of the empty weight of the aircraft.

VV[8.3.0.4] Post-flight inspection.

For multi-motor electric aircraft, the team can choose to use one battery powering all motors or one battery per motor. In the latter case, all batteries must comply with the removal time requirement in **R[8.3.0.4]**, and the dry tank is considered when all batteries lose charge.

R[8.3.0.5] The team must submit on the website www.aerocf.com.br along with the Project Report the manufacturer documentation of the motor(s) battery(ies) indicating their characteristics (voltage, charge, number of cells, and any other relevant information affecting the motor power).

NC[8.3.0.5] Non-compliance correction or the aircraft will be grounded.

VV[8.3.0.5] Evaluation of report and safety inspection.

8.4 Maximum Eligible Weight - Advanced Class

- R[8.4.0.1] The total weight of the aircraft (empty weight + maximum payload + glider) must not exceed 20 kg.
- NC[8.4.0.1] Battery score will be zeroed.
- VV[8.4.0.1] Post-flight inspection.

8.5 Electronics

8.5.1 Battery Packs

- R[8.5.1.1] The battery pack of the aircraft's flight control system must have a minimum of 1000mAh.
- NC[8.5.1.1] Non-compliance correction or aircraft will be prohibited from flying.
- VV[8.5.1.1] Evaluation of report and safety inspection.

For the acquisition and transmission system and flight control of the glider (Section 8.7), the determination of the battery capacity is the responsibility of the team.

The determination of the battery capacity of the propulsion system is the responsibility of the team, always observing requirement R[8.3.0.2].

- R[8.5.1.2] Aircraft shall not use systems with Battery Eliminator Circuits that would allow the use of a single battery pack to power the motor and electrical systems.
- NC[8.5.1.2] Non-compliance correction or aircraft will be prohibited from flying.
- VV[8.5.1.2] Evaluation of report and safety inspection.

For details on the electrical installation of extensions manufactured by the team, see Section 6.21.

Additionally, all general requirements regarding batteries from Section 6.12 must be met for all batteries, whether for the control system, data acquisition system, glider control (Section 8.7), or the propulsion system.

8.5.2 Flight Control Systems

The use of gyroscopes and any type of automatic control system is allowed.

8.6 Special Requirements for Multi-Motors

Aircraft with more than 1 motor (multi-motors) must meet the requirements of this section.

- R[8.6.0.1] A report on flight with the failed critical motor must be submitted through the website www.aerocf.com.br as per the deadline presented in **Appendix 9**.
- NC[8.6.0.1] Aircraft prohibited from flying in the competition.
- VV[8.6.0.1] Report evaluation.

- R[8.6.0.2]** The report on flight with a failed motor must have a maximum of five (5) pages (reference value), detailing the theoretical analysis or at least one practical test for the case of loss of the most critical motor in the most critical flight condition.
- NC[8.6.0.2]** Aircraft prohibited from flying in the competition.
- VV[8.6.0.2]** Report evaluation.

The critical motor is the one that, due to its failure, and keeping the other motor at maximum power, generates the greatest yaw moment. For example, in an aircraft with 4 motors, the failure of the motors closest to the wingtips is more critical than the failure of the central motors. The team is responsible for identifying the most critical condition, verifying the necessary analyses (considering the dynamics of the failure and the pilot's perception), and how the test should be conducted.

- R[8.6.0.3]** In the report on flight with a failed critical motor, the team must demonstrate that the roll and yaw control surfaces are sufficiently sized to ensure that the aircraft can fly safely with the remaining motors at maximum power.
- NC[8.6.0.3]** Aircraft prohibited from flying in the competition.
- VV[8.6.0.3]** Report evaluation.

An acceptable way to demonstrate this safety is to show that the aircraft is capable of maintaining a slip-free flight, with a bank angle (roll) of less than or equal to 5° , using only 65% of the total rudder command and 50% of the total aileron command, flying at a speed equal to or less than $1.1 \times V_S$ (where V_S is the stall speed).

- R[8.6.0.4]** If the team chooses different methodologies to demonstrate safety, it must show that the adopted methodology has a safety level at least equal to the aforementioned.
- NC[8.6.0.4]** Aircraft prohibited from flying in the competition.
- VV[8.6.0.4]** Report evaluation.

8.7 Multi-Mission Requirement

Teams in the Advanced class will have the option to choose, for each flight battery, whether they want to perform the "Performance Campaign" or the "Systems Campaign", summarized below (more details in their respective subsequent subchapters).

Performance Campaign: The aircraft must take off, perform the normal flight circuit, and land carrying payload in its respective cargo compartment. Optionally, the aircraft may jettison, via pilot command, a glider entirely made of Depron and also contain its own payload (total weight limited to 1.0 kg). The team will be awarded a bonus if the glider lands belly-side down without damage preventing it from making a new flight (even if the glider rolls during landing and stops with its ventral part on the ground, the bonus will be considered valid). The Performance Campaign glider must not have autonomous control systems.

Systems Campaign: The aircraft must perform bonus missions of onboard systems, as described in section Section 8.8. The onboard system must be entirely contained in a jettisonable glider via pilot command. The glider must be entirely made of Depron (except

for the electronic systems in it). This glider must land as close as possible to a ground target determined by the technical committee through geographic coordinates made available via Wi-Fi network described in appendix Appendix 12. Additionally, the onboard system of the glider may, additionally, record the DAS and HUD video (bonus missions). The validation of the Systems Campaign score will not be affected by any invalid flights of the “mothership”. In other words, even if the aircraft crashes or fails to land on the runway, the glider systems score will be evaluated post-flight (provided, obviously, that the integrity of the data has not been compromised by the eventual glider crash). For the Systems Campaign score to be considered, the aircraft must at least achieve a valid takeoff in the respective flight battery Section 8.11.

R[8.7.0.1] The material of the glider must be exclusively Depron® (or XPS, Foamex, and Styrodur), and the team may use balsa wood sticks only to stabilize the wing structure (main lifting profile), carbon or glass fiber roving (in the form of a thread, without forming fabric), epoxy resin, fiberglass-reinforced or not adhesive tapes, and other adhesives for joints.

NC[8.7.0.1] The glider is prohibited from being used in the battery.

VV[8.7.0.1] Safety inspection.

The use of rigid rods of any composite material is prohibited (to avoid rigid or sharp tips in cases of falling on unauthorized areas). Gliders with rigid rods (except balsa) will not be authorized to fly, and the team is subject to disqualification if this material is somehow concealed in the glider.

R[8.7.0.2] In case of multi-mission flights in different batteries, the base design of the aircraft (mothership) must be the same for both variants (Performance and Systems).

NC[8.7.0.2] The team is prohibited from flying.

VV[8.7.0.2] Safety inspection.

The use of two different subprojects/variants of different gliders (one for each campaign) will be allowed, provided they come from the same original project (each can be subtly optimized for its respective mission). In other words, for both campaigns of the Advanced class (Systems and Performance), the gliders used must be exactly the same in configuration and share the same aerodynamic, structural, and manufacturing project, that is, they must be composed of the same basic parts and manufactured equivalently. Only minor modifications will be accepted for possible optimization of the glider for its respective campaign, such as: installation of systems, wiring, and control surfaces for the Systems Campaign glider and another glider composed of the same basic structure and parts, but with possible simplifications more suitable for the Performance Campaign. The assessment of the correct mandatory use of the same project and the same primary structure for both campaigns will be made by a member of the Technical Committee who, armed with the glider blueprint (to be printed and provided by the team during the competition), will make the appropriate judgment of this requirement. In cases of base projects judged as different for both campaigns, the glider will be prohibited from flying.

8.8 Onboard Systems Campaign Requirements

The missions described in the subsections of this chapter will be independent of each other and considered as “bonus missions”.

8.8.1 Bonus: DAS

R[8.8.1.1] To obtain a DAS bonus, the glider must have an onboard system capable of measuring and recording at least three (3) parameters from distinct groups in the table below, where the parameter from group 1 is mandatory. In other words, the aircraft must measure and record the parameter from group 1 and at least 2 others from the table below, with these two being from different groups.

Group	Parameter	Unit	Description
1	Time	Seconds	This parameter corresponds to the time base of the recording in seconds, starting at 0 (zero) at 00:00:00 of the day (UTC-3). In other words, the system must have an embedded clock. Example: for a flight starting at 14:25:32.3 (2:25:32.3 PM), this parameter should indicate 51932.3 s.
2	XGPS	m	GPS positions indicating, in a top view, the trajectory developed by the aircraft.
	YGPS	m	
	ZGPS	m	Altitude position values measured via GPS.
3	ELEV	deg	Commanded deflection of elevator or analogous surface
	AIL	deg	Commanded deflection of Aileron or analogous surface
	RUD	deg	Commanded deflection of Rudder or analogous surface
4	THETA	deg	Attitude (θ)
	PHI	deg	Bank Angle (ϕ)
5	Status	-	Aircraft stage during the mission, being (1) attached to the main aircraft (<i>attached</i>), (2) gliding (<i>deployed</i>), or (3) landed (<i>landed</i>)
6	AOA	deg	Aircraft Angle of Attack (α)
	AOS	deg	Aircraft Sideslip Angle (β)

NC[8.8.1.1] DAS bonus score will be zeroed.

VV[8.8.1.1] Post-flight inspection.

R[8.8.1.2] The sampling of the onboard system must be at least **10 Hz** for all parameters specified in requirement **R[8.8.1.1]**.

NC[8.8.1.2] Flight score may be zeroed if data analysis is not possible due to low sampling.

VV[8.8.1.2] Post-flight inspection.

R[8.8.1.3] The onboard system must output a text file containing the parameters specified in requirement **R[8.8.1.1]**, organized in columns, one per parameter, with the name identical to that presented in the **Parameter** column of the table shown in requirement **R[8.8.1.1]**, and with each column separated by **tab** (tabulation).

NC[8.8.1.3] Flight score may be zeroed if extensive work is needed to reformat the file according to this requirement.

VV[8.8.1.3] Post-flight inspection.

R[8.8.1.4] Parameter names must be displayed in the first line of the file according to **R[8.8.1.3]**. The second line must contain the units, also following the table in **R[8.8.1.1]**. From the third line onwards, the data must be presented.

NC[8.8.1.4] Flight score may be zeroed if extensive work is needed to reformat the file according to this requirement.

VV[8.8.1.4] Post-flight inspection.

R[8.8.1.5] There must be no post-processing of flight data outside the glider. The file with the specified format in requirements **R[8.8.1.2]** to **R[8.8.1.4]** must come ready from the aircraft and be delivered to the Technical Committee.

NC[8.8.1.5] Flight score will be zeroed.

VV[8.8.1.5] Post-flight inspection.

R[8.8.1.6] The data must be transferred to the Technical Committee via USB equipment (with a USB drive, for example).

NC[8.8.1.6] Flight score will be zeroed.

VV[8.8.1.6] Post-flight inspection.

R[8.8.1.7] The data acquisition and transmission system must be designed and built by the team.

NC[8.8.1.7] Correction of non-compliance or the aircraft will be prohibited from flying.

VV[8.8.1.7] Evaluation of report and safety inspection.

The data acquisition and transmission system may incorporate commercially available components but cannot be characterized as a complete commercially sold package. Programmable systems such as Arduino®, Raspberry®, and Pixhawk® may be used.

R[8.8.1.8] The system must be entirely embedded in the glider and must not have any connection with the aircraft other than the mechanism for releasing the glider during flight.

NC[8.8.1.8] Correction of non-compliance or the aircraft will be prohibited from flying.

VV[8.8.1.8] Evaluation of report and safety inspection.

R[8.8.1.9] The onboard system's battery must also comply with the requirements of Section 6.12.

NC[8.8.1.9] Correction of non-compliance or the aircraft will be prohibited from flying.

VV[8.8.1.9] Evaluation of report and safety inspection.

R[8.8.1.10] The glider and systems assembly must not exceed a mass of 1 kg.

NC[8.8.1.10] Flight score will be zeroed.

VV[8.8.1.10] Post-flight inspection.

R[8.8.1.11] Details of the system, as well as its operating principle, must be described in the Onboard Systems Report (Section 11.3).

NC[8.8.1.11] Onboard Systems Report score (Section 11.3) will be affected.

VV[8.8.1.11] Report evaluation.

8.8.2 Bonus: Autonomous Landing

Teams may choose to manually jettison (triggered by the pilot) the glider based on information obtained through a Wi-Fi network configured by the Technical Committee or by reading a QR code by a team member on the ground and sent to the onboard system. The information provided via Wi-Fi network or QR code will be a number from 1 to 4, indicating which of the four targets will be the glider's destination, along with the coordinates of the respective target. With the decoded information, the glider must autonomously land on the correct target, or as close as possible to it. To do so, the glider must have an onboard autonomous piloting system capable of guiding it to the identified target without any external interference (human or computational). The bonus for this mission will be given according to the distance from the final position of the glider on the ground to the target defined by the Wi-Fi network and QR code. If the distance is greater than 10 meters, the bonus will be zero. The glider launch must be performed at a height considered safe by the runway judge (Technical Committee). The judge will be stationed with the team pilot and will authorize jettisoning, only after which the pilot can perform the launch.

Important: If the team installs pitot tubes on the glider, for safety reasons, these must be positioned inside the fuselage, with only one opening for wind entry into the sensor. The interference of this type of installation in the value calculated from the sensor data can be adjusted via software. Additionally, no sensor or other rigid element of the onboard system should be installed in the glider's nose.

- R[8.8.2.1] The glider must not have pitot tubes external to the fuselage.
- NC[8.8.2.1] Non-compliance: Glider grounded.
- VV[8.8.2.1] Safety inspection.

- R[8.8.2.2] The glider must not have any rigid elements installed in the nose.
- NC[8.8.2.2] Non-compliance: Glider grounded.
- VV[8.8.2.2] Safety inspection.

The format of the message sent via Wi-Fi or provided through the QR code will be as follows: {"target": N, "coordinates": {"latitude": $\pm ff.ffffffffffffffffffff$, "longitude": $\pm ff.ffffffffffffffffffff$ }}

Where:

- N: Natural number from 1 to 4
- $\pm ff.ffffffffffffffffffff$: Decimal Latitude/Longitude, with trailing zeros omitted in the message according to available precision



Figura 8.1: Example of QR code.

8.8.3 Bonus: HUD

Teams may choose to install a camera to generate overlaid symbology on the video recorded during the glider flight. The symbology data will be counted for bonus points, according to the section Subsection 8.10.9. The HUD symbology may contain the following information for bonus purposes:

- Calibrated Airspeed (CAS): Indicated airspeed corrected for position and instrument errors, calculated from impact pressure.
- Altitude: Geometric altitude of the aircraft above sea level.
- Status: Current situation of the glider, can be ATT (attached to mother ship), DPL (in flight), or LND (on the ground).
- Magnetic Heading: Direction in which the glider's nose is currently pointing, with reference to the magnetic north indicated by a compass.
- Load Factor in Z: Force exerted by the aircraft on its own vertical structure, given in multiples of g (acceleration due to gravity).
- GPS Time: Time provided by the global positioning system. In the HUD, it must be converted to HH:MM:SS format.

8.9 Performance Campaign Requirements

The missions described in the subsections of this chapter refer to the Performance Campaign, focusing on payload transport and unmanned glider.

8.9.1 Payload and Cargo Compartment

Cargo Compartment

- R[8.9.1.1]** The cargo compartment must be fully enclosed, with cargo access doors that must be part of the aircraft.
- NC[8.9.1.1]** If verified before the flight: non-compliance correction, penalized by project changes according to **Section 6.9** or the aircraft will be grounded. If verified after the flight: invalidated flight.
- VV[8.9.1.1]** Safety inspection and post-flight inspection.

Explaining further the requirement **R[8.9.1.1]**, airflow should not come into contact with the cargo or cargo support; in other words, any geometry defining the aerodynamic shape of the aircraft should be part of the aircraft, counted as aircraft weight, and not as paid cargo. If at the weighing process it is found that the paid cargo (all cargo to be weighed, i.e., cargo and cargo support) has external components, the flight will be invalidated, and the team may make the necessary changes with penalties as per **Section 6.9** on project changes.

Payload

Total payload consists of the sum of the following weights:

- Cargo
- Cargo support
- Propulsion system (exclusively) battery (see Section 8.3). Up to 1 kg of battery can be considered payload. Any excess over this value will be considered empty weight, even if the battery removal requirements presented in Section 8.3 are met.
- Glider (see Subsection 8.9.2)

The weight of the aircraft and the excess of the exclusive propulsion system battery together with the ESC are **not** considered as payload (Refer to **Appendix 1**).

- R[8.9.1.2]** The payload must not contain lead parts.
- NC[8.9.1.2]** Non-compliance correction or the aircraft will be grounded.
- VV[8.9.1.2]** Safety inspection.

- R[8.9.1.3]** The aircraft must not have ballast or any other lead parts.
- NC[8.9.1.3]** Non-compliance correction or the aircraft will be grounded.
- VV[8.9.1.3]** Safety inspection.

The locking mechanism of the cargo support in the aircraft can be part of the cargo support or of the aircraft structure itself. If this mechanism is part of the cargo support, it is also counted as payload.

- R[8.9.1.4]** The payload must be securely fastened in the cargo compartment (see Section 6.15) to prevent its movement during flight.
- NC[8.9.1.4]** Non-compliance correction or the aircraft will be grounded.
- VV[8.9.1.4]** Evaluation of report and safety inspection.

- R[8.9.1.5]** The payload must not structurally contribute to the stability of the aircraft structure or be part of it.
- NC[8.9.1.5]** Non-compliance correction, penalized by project changes according to Section 6.9, or the aircraft will be grounded.
- VV[8.9.1.5]** Evaluation of report and safety inspection.

It is the teams' responsibility to provide their own cargo. The loaded weight verification will be done after the flight in the presence of officials. The aircraft that does not allow the removal of the support for weighing will not have this weight included in the payload.

The aircraft can have as many sets of cargo + support as the team deems appropriate in the design.

8.9.2 Glider Jettison

The team may optionally jettison a glider during the flight so that it lands successfully (belly landing) anywhere in the flight box, and without breaking any critical parts of the glider (it must be capable of flying a new mission without repairs). Fulfilling the jettison will result in a bonus as defined in section Subsection 8.10.1.

- R[8.9.2.1]** To be awarded a bonus after landing, the glider must be stationary with its ventral side on the ground.
- NC[8.9.2.1]** Glider landing bonus is nullified.
- VV[8.9.2.1]** Fiscal inspection on the runway.

8.10 Scoring - Advanced Class

The score of each flight is the sum of the following scores and bonuses described in the subsections of this chapter:

Performance Campaign: $B_{AP} + B_{PP} + P_{CP} + P_{AC} + B_{DPO} + B_{RC}$ Systems Campaign: $B_{AP} + B_{PP} + B_{PO} + B_{AD} + B_{HUD} + B_{PA}$

The Multimission Score (P_{MM} , **Subsection 8.10.13**) and penalties such as lateral escape (**Subsection 10.1.8**), among others (**Appendix 7**), will be accounted for in the final team score.

8.10.1 Glider Jettison Bonus [per flight battery - Both Campaigns]

This bonus will be awarded to the team that successfully completes the Glider Jettison Mission (Subsection 8.9.2), which consists of jettisoning a glider in flight through pilot action. The glider must glide as stable as possible and belly land within the flight competition area. If the glider successfully lands (without breaking any critical components), the team will receive the following bonus:

$$B_{AP} = 20.0 \times AP \quad (8.1)$$

Where B_{AP} Points obtained as a glider jettison bonus; AP is 1 if the glider can finish the flight with its belly on the ground, and zero otherwise.

Only points related to the best battery will be considered in the team's final score. This bonus is not cumulative.

Note: For the Performance Campaign, even if the glider cannot land near the target defined by the mission, it can still score for a belly landing according to this section.

8.10.2 Glider Weight Bonus [per flight battery - Both Campaigns]

This bonus will be awarded to the team that successfully completes the Glider Jettison Mission (Subsection 8.9.2), which consists of jettisoning a glider in flight through pilot action. The glider must glide as stable as possible and belly land within the flight competition area. If the glider successfully lands (without breaking any critical components), the team will receive the following bonus:

$$\begin{cases} B_{PP} = 0.075 \times PP & \text{if } 0 < PP \leq 400, \\ B_{PP} = 0.066667 \times PP + 56.66667 & \text{if } 400 < PP \leq 850, \\ B_{PP} = -0.4 \times PP + 340 & \text{if } 850 < PP \leq 1000. \end{cases}$$

B_{PP} : Glider Weight Bonus/Penalty PP : Measured Weight of the Glider, in g

Note that gliders weighing more than 850 g will incur a linear penalty according to weight. Gliders weighing above 1 kg will not be accepted (the full battery score will be zeroed).

8.10.3 Maximum Loaded Payload [per flight battery - Performance Campaign]

For each validated flight (see Subsection 10.1.9), a score proportional to the carried payload will be computed as follows:

$$P_{CP} = 6.8 \times \exp\left(\frac{CP}{5}\right) \quad (8.2)$$

Where P_{CP} points obtained due to the carried payload; CP is the total payload (in kg) - Subsection 8.9.1; $\exp(x)$ is the function that returns Euler's number $e = 2.718281$ raised to the power of x .

8.10.4 “Accuracy” of Payload [per flight battery - Performance Campaign]

Additional points will be added based on the accuracy of the payload prediction. The resulting score for this “accuracy” is calculated by the following formula:

$$P_{AC} = 30 - 830 \times \text{abs} \left(\frac{CP_{EXPECTED} - CP_{EXECUTED}}{CP_{EXPECTED}} \right)^{1.75} \quad (8.3)$$

As long as the expression has a positive value. Otherwise, the score will be zero (0). Where P_{AC} Payload “accuracy” score; $CP_{EXPECTED}$ Predicted payload (obtained from the payload capacity prediction graph - Section 11.5); $CP_{EXECUTED}$ Real payload (obtained in flight) - Subsection 8.9.1.

8.10.5 Landing Distance to Stop [per flight battery - Performance Campaign]

R[8.10.5.1] The aircraft must come to a complete stop after landing within the runway area defined in requirement **R[10.1.8.1]**.

NC[8.10.5.1] The team does not earn a landing bonus.

VV[8.10.5.1] Procedures executed on the runway. There will be demarcated lines marking the runway limits and officials.

Teams that perform a valid flight (see Subsection 10.1.9), and comply with requirement **R[8.10.5.1]**, will receive a bonus as follows:

$$B_{DPO} = 1.0 \times CP \quad (8.4)$$

Where B_{DPO} Points obtained as a bonus for stopping within the specified distance; CP Payload (kg) - Subsection 8.9.1

Only points related to the best battery will be considered in the team’s final score. This bonus is not cumulative.

8.10.6 Cargo Removal Time [per flight battery - Performance Campaign]

The opening of the cargo compartment after each valid flight will be timed, and bonus points will be given to teams that manage to complete the operation (i.e., open the cargo compartment and remove all cargo within a maximum time), following this bonus rule:

$$B_{RC} = 17.15 \cdot t^{-0.75} \text{ if } t < 60 \text{ seconds} \quad (8.5)$$

Where B_{RC} Bonus for cargo removal time; t time taken to remove cargo, in seconds.

If the cargo is not removed within the maximum time or the team chooses not to measure the time, the bonus will be zero (0). If the cargo is not removed within the maximum time of 10 minutes, the flight will be invalidated. The cargo will be considered according to the definition in section 8.9.1.

R[8.10.6.1] Up to two team members can perform the cargo removal.

NC[8.10.6.1] The team does not earn the cargo removal time bonus.

VV[8.10.6.1] Post-flight inspection.

R[8.10.6.2] No cutting tools should be used during cargo removal to cut the lid or any other component of the aircraft.

NC[8.10.6.2] The team does not earn the cargo removal time bonus.

VV[8.10.6.2] Post-flight inspection.

R[8.10.6.3] Every piece or component of the cargo compartment must be fit for reuse after payload removal.

NC[8.10.6.3] The team does not earn the cargo removal time bonus.

VV[8.10.6.3] Post-flight inspection.

R[8.10.6.4] Adhesive and/or sticking elements may be used as covering but must not be used as the cargo compartment door closure mechanism.

NC[8.10.6.4] The team does not earn the cargo removal time bonus.

VV[8.10.6.4] Post-flight inspection.

According to requirements R[8.10.6.2] and R[8.10.6.3], it is understood that no component may be destroyed upon opening even if unintentionally. The cargo compartment closure systems must be such that they can be reused without having their characteristics modified. **Tapes or any other adhesive components cannot be reused, therefore their use as the cargo compartment lid or as the door closure mechanism results in the team forfeiting the bonus.** The team must adopt other non-adhesive solutions for door closure.

The removal of the cargo from the cargo support is not necessary, i.e., the cargo removal time counting will be terminated after the removal of the cargo and cargo support assembly from the aircraft's cargo compartment.

For electrically powered aircraft opting to use the propulsion system battery as payload credit (see Subsection 8.9.1), the removal of this battery is not considered in the time measurement.

8.10.7 Bonus for Valid Landing [per flight battery - Systems Campaign]

R[8.10.7.1] The aircraft must come to a complete stop after landing within the delimited runway area specified in requirement R[10.1.8.1].

NC[8.10.7.1] The team does not receive a landing bonus.

VV[8.10.7.1] Procedures carried out on the runway. There will be demarcated stripes indicating the runway boundaries and inspectors.

Teams that perform a valid flight (see Subsection 10.1.9) and meet requirement R[8.10.7.1], will receive a bonus based on the following equation:

$$B_{PO} = 10 \times VLD \quad (8.6)$$

Where B_{PO} is the bonus for valid landing; VLD is 1 if requirement R[8.10.7.1] is met, and 0 otherwise.

Only points related to the best battery will be considered in the team's final score. This bonus will not be cumulative.

8.10.8 Data Acquisition Score [per flight battery - Systems Campaign]

This score will be attributed based on the number of optional parameters recorded and the quality of the recording.

As specified in requirement **R[8.8.1.1]**, the acquisition system must compulsorily provide group 1 parameter (time) for this bonus to be considered. Besides this parameter, the team may select, as desired, other parameters from the same table as **R[8.8.1.1]**. Parameters not listed in the table will be disregarded and not computed for scoring evaluation.

In addition to the group 1 parameter, the team will receive a bonus score for each group successfully recorded, weighted according to Subsection 8.10.10.

R[8.10.8.1] Optional parameters for obtaining the bonus must comply with requirements **R[8.8.1.2]** to **R[8.8.1.11]** of Section 8.8.

NC[8.10.8.1] Parameters not complying with the rule will be disregarded for the bonus.

VV[8.10.8.1] Post-flight inspection.

The data acquisition bonus will be based on the following equation:

$$B_{AD} = 3 \times \sum NOTE_P \quad (8.7)$$

Where B_{AD} is the data acquisition bonus; $NOTE_P$ is the sum of notes assigned to each measured group, considering the highest note among the parameters of each group, as described in Subsection 8.10.10.

8.10.9 HUD Bonus [per flight battery - Systems Campaign]

R[8.10.9.1] The team must record during the flight (onboard system or ground station) a video with graphical representation of the recorded parameters overlaid on it. The display should contain an artificial horizon overlaid on the real horizon image similar to the HUD (Head-Up Display) typically present in military aircraft (augmented reality), representing theta and phi (pitch and roll, respectively), along with separate frames displaying the other recorded parameters (see examples in the figure below). The video must be delivered on a flash drive or memory card and be in AVI, WMV, or MP4 format. Overlaying the symbology on the video image may be done post-flight, provided it does not exceed a time limit of 5 minutes and is supervised by an inspector.

NC[8.10.9.1] Bonus B_{HA} will be zeroed.

VV[8.10.9.1] Post-flight inspection (all parameters must be visible and legible).

Examples of possible video configurations:



Figura 8.2: Example of possible video configuration.

The display configuration does not necessarily need to be identical to the one exemplified in the figure above, as it is used only as a reference. The team may also define the resolution and refresh rate of the parameters to be displayed, as long as they are consistent with the variation of the parameters throughout the flight and compatible with the recorded data.

The bonus will be as follows:

$$B_{HUD} = P_{HUD} \times \left(9 \times NOTE_{HUD} + \sum NOTE_{AUX} \right) \quad (8.8)$$

Where B_{HUD} is the Bonus for using the Artificial Horizon; P_{HUD} is 1 if the HUD overlay on the video is implemented, 0 otherwise; $NOTE_{HUD}$ is the note assigned to the attitude and roll angle indication of the HUD, as described in section Subsection 8.10.10. The note is unique for these two parameters. In other words, the attitude indicator of the HUD (horizontal bars) must be aligned with the real horizon shown in the video; $NOTE_{AUX}$ is the sum of notes assigned to each auxiliary parameter indicated on the Artificial Horizon, as described in section Subsection 8.10.10. The auxiliary parameters of the Artificial Horizon that count towards this bonus are:

- Calibrated speed
- Altitude
- Status (as in Subsection 8.8.3)
- Magnetic Heading
- Load Factor in Z
- GPS Time (converted to HH:MM:SS format)

8.10.10 Quality of Parameter Recording (grading criterion)

The quality of parameter recording will be evaluated by assigning a note according to the table below. Each recorded parameter will be individually evaluated to compose the sum of the equation in Subsection 8.10.8.

Cases not covered in the table below will be judged as they arise, assigning the note that the Technical Committee considers closest to one of the cases in the table.

Description of the criterion to be met. The criteria below are subjective and will be evaluated by comparing measurements from various teams.	Parameter Noise Level		
	Low (easy to read)	Medium (ham-pers reading)	High (almost pre-vents reading)
Did not record the parameter. (the parameter column does not exist in the file or came in blank)	0	0	0
Recorded, but the data is inconsistent. The data appears in such a way that it is not possible to identify what is happening with the aircraft. Example 1: The signal shows “maneuvers” that were not performed. Example 2: Parameters show physically impossible data (extremely low speeds, inconsistent altitudes, etc...)	0	0	0
Parameter recorded and data appears coherent, but there are several recording failures in over 30% of the flight (30% is a reference value).	1	0.5	0
Parameter recorded and data appears coherent, but there are several recording failures in less than 30% of the flight (30% is a reference value, if failures occur at important moments, the score may be reduced).	2	1	0.5
Recorded as expected.	3	2	1

8.10.11 Glider Landing Bonus [per flight battery - Systems Campaign]

This bonus will be awarded to the team that successfully completes the Autonomous Landing Mission (Subsection 8.8.2), which involves capturing the QR code or information provided via Wi-Fi network and landing the glider as close as possible to the decoded target. If the onboard system is capable of decoding and causing the glider to land close to the selected target, the team will receive a bonus according to the following equation:

$$B_{PA} = \max(0, C \cdot (-10 \times d + 100)) \quad (8.9)$$

B_{PA} : Bonus for autonomous landing C : Type of information capture about the target (Wi-Fi = 1; QR Code = 0.7) d : Distance from the glider to the target, in meters. If greater than 10 m, the bonus will be zero.

8.10.12 Reliability Bonus [single bonus]

In order to benefit teams whose project has high reliability and manage to make more than one flight with a high load or high systems score, the following bonus will be awarded:

$$B_{CF} = 20 \times \left[1 - \left(5 \times \frac{P_{B1} - P_{B2}}{P_{B1}} \right)^2 \right] \quad (8.10)$$

Provided that the expression has a positive value. Otherwise, the score will be zero (0). Where P_{B1} is the total score of the best flight battery; P_{B2} is the total score of the second-best flight battery.

8.10.13 Multimission Scoring

Aiming to benefit teams whose project is versatile and multidisciplinary, the following scoring will be assigned:

$$P_{MM} = \max(0.15 \times P_{DES} + P_{SIS}, 0.15 \times P_{SIS} + P_{DES}) \quad (8.11)$$

P_{MM} : Final score for multimission flights P_{DES} : Highest score of the team in a battery where they opted for the Performance Campaign P_{SIS} : Highest score of the team in a battery where they opted for the Systems Campaign

If the team has flown only one type of campaign, the multimission score will be equal to the maximum battery score they obtained throughout the competition.

8.11 Valid Takeoff

R[8.11.0.1] The aircraft must take off and fly over an obstacle of **70 cm in height** and **10 m in width** positioned 55 m away from the beginning of the takeoff run, at the end of the official runway.

NC[8.11.0.1] Flight invalidated or penalty applied as per **R[8.11.0.4]** and **NC[8.11.0.4]**.

VV[8.11.0.1] Runway. There will be an obstacle verified by referees, with the main landing gear as the reference point for visual verification.



Figura 8.3: Valid takeoff for Advanced class: obstacle.

The device designed to emulate the takeoff obstacle is detailed in **Appendix 11**. There will be a device at each end of the runway to allow takeoff in the direction defined by the track judge. Auxiliary markings on the runway from 40 to 55 meters away, spaced 5 meters apart, will be available to provide visual feedback to the pilot and thus allow the decision to rotate the aircraft at the point defined by the team. The tape has its striped side facing upwards (**Appendix 11**).

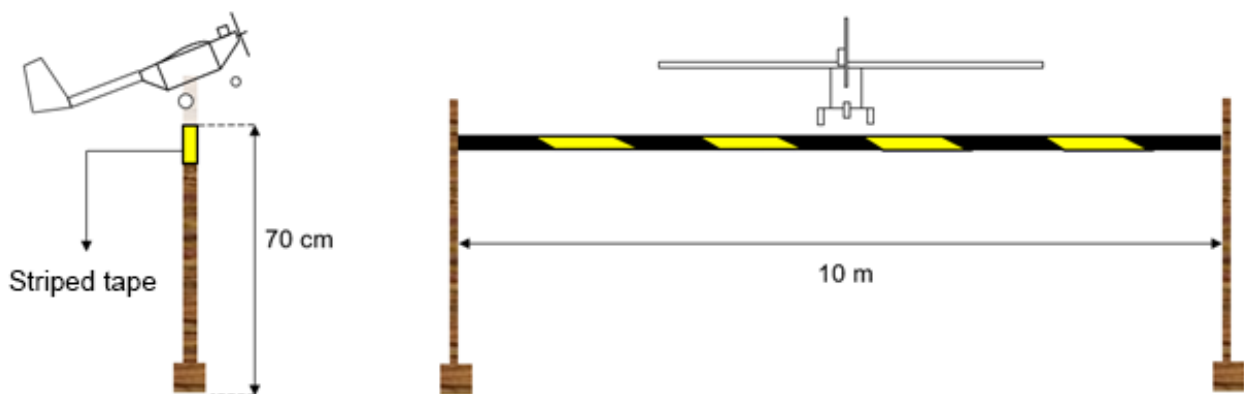

Figura 8.4: Valid takeoff for Advanced class: runway with obstacle.

The end of the takeoff runway, marked by the obstacle, will be supervised by a runway referee, as illustrated in the following figure.

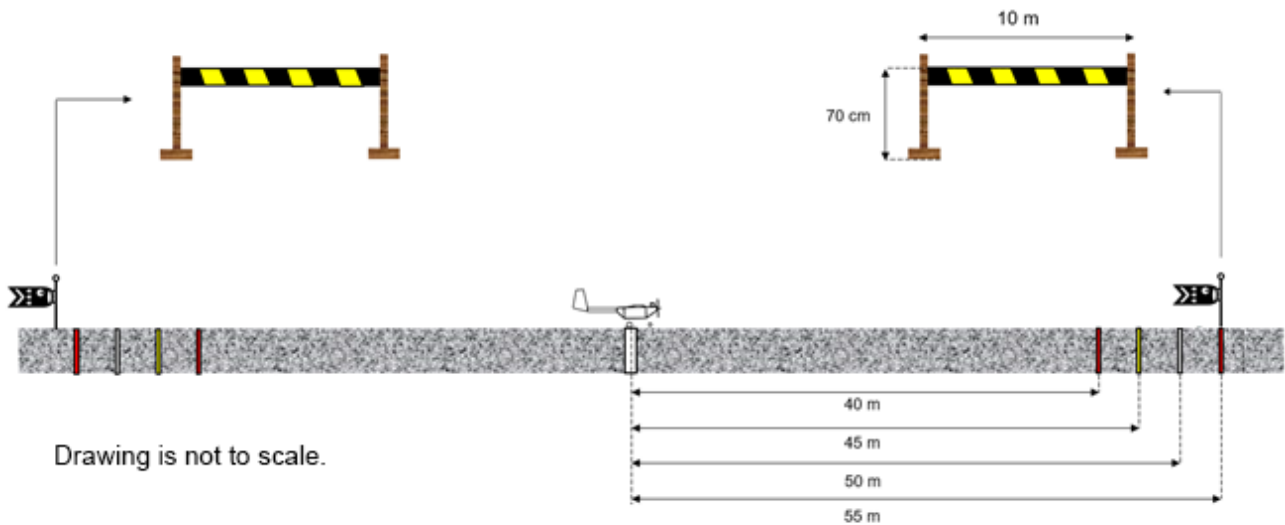

Figura 8.5: Valid takeoff for Advanced class.

R[8.11.0.2] The obstacle (poles and tape) must not suffer damage during takeoff.

NC[8.11.0.2] Subject to penalty or flight invalidation as judged case by case by the Technical Committee and Runway Judge.

VV[8.11.0.2] Verification by the runway referee.

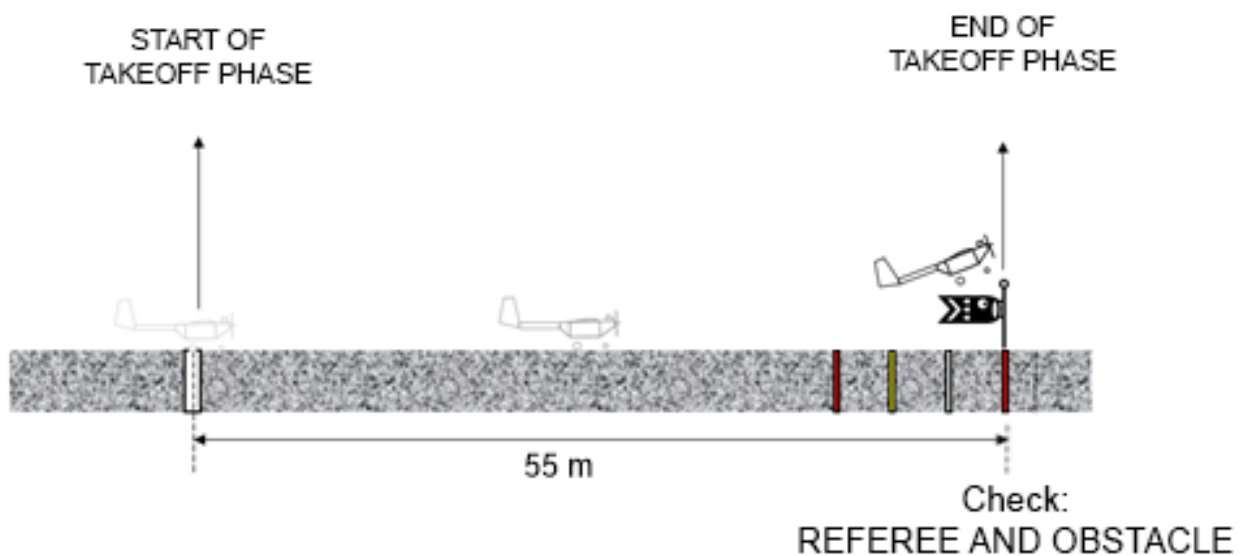
Touching the tape does not necessarily invalidate the flight if it remains intact, but its complete rupture invalidates the takeoff as per **R[8.11.0.3]**.

R[8.11.0.3] The tape of the obstacle must not suffer damage leading to complete rupture during takeoff.

NC[8.11.0.3] Flight invalidated.

VV[8.11.0.3] Verification by the runway referee.

Flight invalidation occurs in cases where the aircraft collides and damages the obstacle without tape rupture, evaluated case by case by the Runway Judge and Technical Committee.

R[8.11.0.4] The aircraft must fly over the obstacle respecting its width.

NC[8.11.0.4] Penalty applied as per **Appendix 7, Section 7.3**.

VV[8.11.0.4] Verification by the runway judge and referees. The main landing gear will be the reference point for verification and must be laterally contained within the width of the obstacle.



Figura 8.6: Invalid and valid takeoff with applicable penalty for the Advanced class.

The striped tape, not being a rigid component, is subject to deformation due to wind. The tape will be the reference for flight validation regardless of deformation.

In the event of a collision with the takeoff obstacle, the aircraft is also subject to structural integrity requirements according to Subsection 10.1.10.

Additionally, takeoff is subject to the requirements of Subsection 10.1.6.

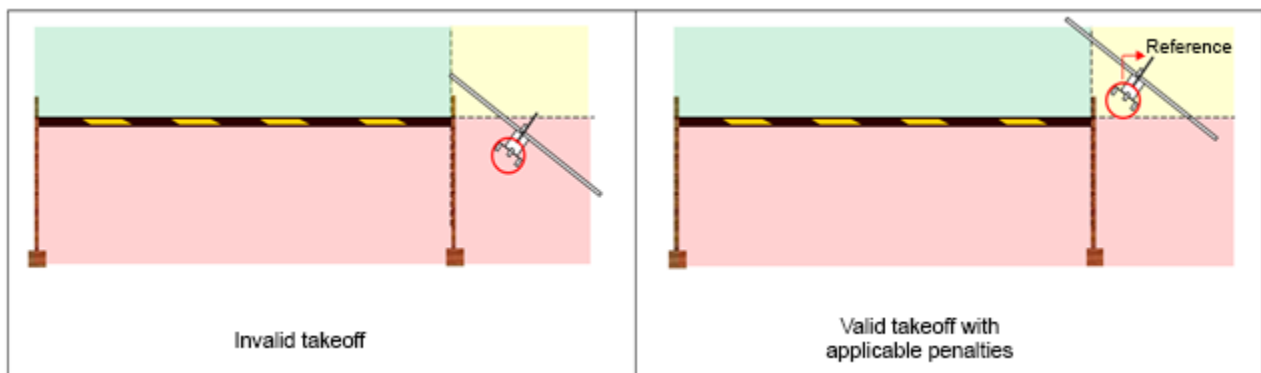
8.11.1 Valid Landing

R[8.11.1.1] The tape of the obstacle must not suffer damage leading to complete rupture during the landing approach.

NC[8.11.1.1] Penalty applied as per **Appendix 7, Section 7.3**.

VV[8.11.1.1] Verification by the runway referee.

In case of collision with the landing approach obstacle, the aircraft is also subject to structural integrity requirements according to Subsection 10.1.10.

Additionally, landing is subject to the requirements of Subsection 10.1.8.

9. Requirements - Micro Class

9.1 Eligibility - Team Members

- R[9.1.0.1] Students must be undergraduate or graduate students (*stricto sensu*) in Engineering, Physics, and Mobility-related Technologies.
- NC[9.1.0.1] Registration not accepted.
- VV[9.1.0.1] Member registration process.
- R[9.1.0.2] Students must submit proof of enrollment for the second academic semester of 2024 (both undergraduate and graduate students) by the date stipulated in **Appendix 9**.
- NC[9.1.0.2] Registration not accepted.
- VV[9.1.0.2] Member registration process.

Pay attention to the requirements of Section 6.1.

9.2 Mission

9.2.1 Introduction

The Micro Class Mission consists of demonstrating and assembling an aircraft within 3 minutes for each phase, taking off from a platform of approximately 4.2 meters in length, and performing a valid flight with the highest payload possible, obeying all applicable requirements of these Rules. Each of these phases will be detailed below.

9.2.2 Disassembly

After completing the safety inspection of the assembled aircraft, at a specific location in the safety inspection zone, the team must place the box near the workbench and, when authorized by the inspector, start the disassembly of the aircraft. This stage will be timed. The timer starts from the inspector's authorization and ends when the aircraft is disassembled and the box is closed (the team must announce when this occurs). Any need to change anything on the aircraft after the announcement will be considered an interruption, which will be timed and have 10 seconds added to the total time.

- R[9.2.2.1] To perform the Mission, the team must present themselves at the safety inspection with the aircraft assembled and out of the box, with the Payload, the Transport Box, and the Radio Controller in hand.
- NC[9.2.2.1] Non-compliance correction or the team loses the battery.
- VV[9.2.2.1] Safety Inspection.
- R[9.2.2.2] At the end of disassembly, the box must be completely closed for transport. Only the Radio Controller and Cargo do not need to be inside the box.

NC[9.2.2.2] The team can move the aircraft parts, but an additional 10-second penalty will be added for each interruption, and the timer will be restarted.

VV[9.2.2.2] Safety Inspection.

R[9.2.2.3] Only tools contained in the box may be used in the disassembly.

NC[9.2.2.3] Disassembly process invalidated, and the team loses the battery.

VV[9.2.2.3] Safety Inspection.

R[9.2.2.4] Only two team members must be present for disassembly.

NC[9.2.2.4] Non-compliance correction or disassembly prevented from starting.

VV[9.2.2.4] Safety Inspection.

R[9.2.2.5] The disassembly time must be less than 2 minutes.

NC[9.2.2.5] Disassembly interrupted, and 9 minutes used in the equation of Subsection 9.7.3.

VV[9.2.2.5] Safety Inspection.

R[9.2.2.6] Every piece or component of the aircraft must be able to be reused after disassembly.

NC[9.2.2.6] Disassembly invalidated, and the team loses the battery.

VV[9.2.2.6] Safety Inspection.

R[9.2.2.7] Adhesive and/or sticky elements can be used as covering but must not be used as mechanisms, fasteners, joints, or connections of detachable components.

NC[9.2.2.7] Disassembly invalidated, and the team loses the battery.

VV[9.2.2.7] Safety Inspection.

By the rules R[9.2.2.6] and R[9.2.2.7], no component can be destroyed in the disassembly. Joints and fasteners must be such that they can be reused without having their characteristics modified. Adhesive tapes or any other adhesive components cannot be reused, therefore their use as fasteners for detachable parts of the aircraft invalidates the flight of the team. Mechanical locks are suggested. Evaluations of possible interference of magnetic joints on electronic components should be described in project reports.

9.2.3 Assembly

After complete disassembly, the team must, when authorized by the inspector, start assembling the aircraft. This process will be timed. The timer starts from the inspector's authorization and ends when the aircraft is assembled (the team must announce when this occurs). Any need to change anything on the aircraft after the announcement will be considered an interruption, which will be timed and have 10 seconds added to the total time.

R[9.2.3.1] Only tools contained in the box may be used in the assembly. The cargo needs to be on the table.

NC[9.2.3.1] Assembly invalidated, and the team loses the battery.

VV[9.2.3.1] Safety Inspection.

R[9.2.3.2] Only two team members must be present for assembly.

NC[9.2.3.2] Non-compliance correction or assembly prevented from starting.

VV[9.2.3.2] Safety Inspection.

R[9.2.3.3] The aircraft must be ready within 3 minutes, not including the 10-second penalties.

NC[9.2.3.3] Assembly timing interrupted, and 9 minutes used in the equation of Subsection 9.7.3.

VV[9.2.3.3] Safety Inspection.

R[9.2.3.4] At the end of the Assembly, the aircraft must be fully assembled and the cargo allocated in it's compartment (in flight condition), except for the motor arm plug and the propeller(s), which must remain inside the box when the team announces that they have finished.

NC[9.2.3.4] The team can change the aircraft, but an additional 10-second penalty will be added for each interruption, and the timer will be restarted.

VV[9.2.3.4] Safety Inspection.

The assembly of the propeller(s) will be allowed after checking the motor rotation direction.

R[9.2.3.5] At the end of the Assembly, 4 items from the Safety Inspection will be rechecked: 1) Amplitude and direction of all commands, 2) Motor rotation direction, 3) Propeller attachment, and 4) CG Position.

NC[9.2.3.5] The team can change the aircraft, but an additional 10-second penalty will be added for each interruption, and the timer will be restarted.

VV[9.2.3.5] Safety Inspection.

Although the propeller(s) does not need to be assembled at the end of the process, tools for propeller assembly must be inside the box.

R[9.2.3.6] The aircraft must be ready for flight and approved in the inspection before being called for the inspection of the next battery.

NC[9.2.3.6] Assembly/inspection interruption, and the aircraft cannot fly in the battery for which it had presented. The team can use the assembly for the next battery for which they were called.

VV[9.2.3.6] Safety Inspection.

9.2.4 Flight

With the aircraft on a platform, the team must connect the motor plug and request permission to start the takeoff. A team member may be behind the platform holding the aircraft. After permission from the Runway Judge, the aircraft must take off by traveling the platform.

Given that the takeoff will be performed on a platform situated on the grass, the surrounding terrain will not be regular, and may contain obstacles of various heights (irregular grass, uneven terrain, airport objects, etc.).

- R[9.2.4.1]** On the takeoff platform, the only external interference allowed on the aircraft will be a team member holding the aircraft, if the team deems it necessary.
- NC[9.2.4.1]** Flight invalidated.
- VV[9.2.4.1]** Track procedures.
-
- R[9.2.4.2]** The aircraft must take off on a platform 4.2 meters long by 82 cm wide, approximately 90 cm high positioned on the grass; perform a 180-degree turn after traveling a distance of 55 meters, perform another 180-degree turn after another 110 meters (55 meters from the takeoff platform, in the opposite direction), and land within 100 meters. Specific changes may be requested by the track judge due to meteorological conditions, in favor of safety. These requests must be complied with.
- NC[9.2.4.2]** Flight invalid.
- VV[9.2.4.2]** Evaluation of report, video of a flight, and runway procedures.
-
- R[9.2.4.3]** After leaving the platform, the aircraft may lose altitude, but must not touch the ground or any other obstacle.
- NC[9.2.4.3]** Invalid takeoff.
- VV[9.2.4.3]** Evaluation of report, video of a flight, and runway procedures.

There will be markings of a rectangular area of approximately 14 meters by 6 meters (dimensions may vary according to obstacles existing over the airport grass), centered with the platform, called the “Takeoff Box”, where the aircraft may stop in case of an unsuccessful takeoff attempt. If the aircraft leaves the platform but lands/falls on the grass within the marked area, the team may, if desired, attempt to takeoff again, provided that the aircraft has not been damaged in the fall, does not exceed the maximum time of four (4) minutes from the beginning of the first attempt, and is within a maximum number of three (3) attempts.

- R[9.2.4.4]** In case of an unsuccessful takeoff, no more than 4 minutes must have elapsed since the start of the timer, the aircraft must not have suffered damage, and must have stopped with the landing gear within the “Takeoff Box”. This can happen up to two times.
- NC[9.2.4.4]** Flight invalidated.
- VV[9.2.4.4]** Runway procedures.

The aircraft may depart laterally from the platform, provided that it does not touch the ground or any other obstacle.

Under no circumstances will the platform be moved. Crosswinds may occur. The takeoff direction will be defined by the Runway Judge in conjunction with the pilot and informed to the Team.

In **Appendix 11**, there are details of the dimensions of the takeoff platform. Since the leveling of the platform will be done with wooden blocks, slight inclinations may occur. The platform may have some waterproofing coating to prevent damage due to rain (not yet defined).

The distances of 55 meters will be marked by the obstacles of the Regular Class, which will always be present and assembled at the height indicated in R[7.8.0.1]. In addition to the obstacles, there will be flags located on the grass at the same distance to facilitate measurement. Track officials will be close to the obstacles and will validate the passage through visual measurement. The landing distance will be given by white stripes on the airport runway.

The image below illustrates the aircraft's flight box. In green the start line of the movement, in red the takeoff box containing the takeoff platform, in blue the flags for making turns, in yellow the landing zone. In white, an illustrative valid trajectory. Specific changes, such as the non-obligatory passing of one of the flags, may be requested by the track judge due to meteorological conditions, in favor of safety. These requests must be complied with.



Figura 9.1: Aircraft Flight Box.

The timer will be activated from the authorization of the Runway Judge and stopped with the total stop of the aircraft. Reinforcing that requirement **R[10.1.8.5]** must be obeyed.

- R[9.2.4.5]** The team must remove the arm plug from the motor battery before handling the aircraft.
- NC[9.2.4.5]** Flight invalidated.
- VV[9.2.4.5]** Runway procedures.

9.3 Motor

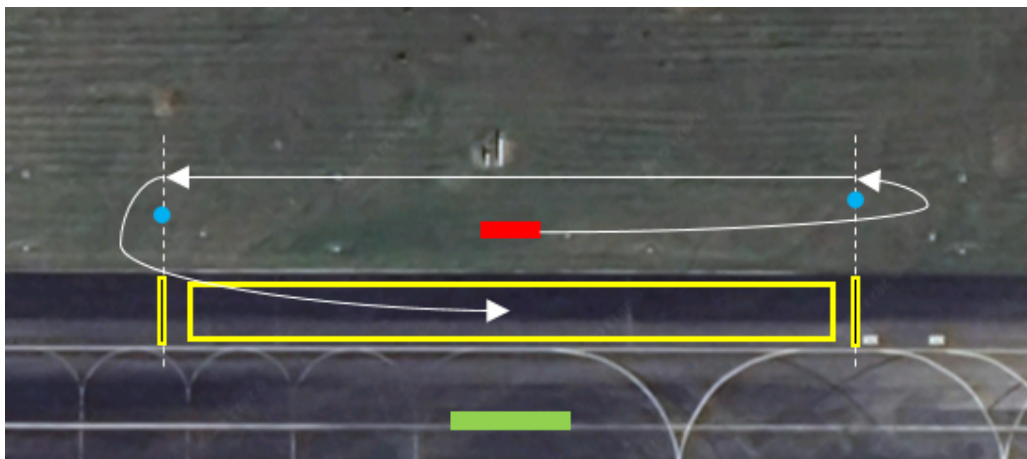
9.3.1 Motor Type

- R[9.3.1.1]** The aircraft must have electric propulsion.

NC[9.3.1.1] Aircraft prohibited from participating in the competition.

VV[9.3.1.1] Evaluation of report and safety inspection.

There is no limitation on the number of motors.

R[9.3.1.2] The motor must be commercial.

NC[9.3.1.2] Aircraft prohibited from participating in the competition.

VV[9.3.1.2] Document submission and report evaluation.

R[9.3.1.3] The manufacturer documentation of the chosen motor(s) indicating its characteristics must be submitted on the website www.aerocct.com.br, along with the Report.

NC[9.3.1.3] Aircraft prohibited from participating in the competition.

VV[9.3.1.3] Document submission and report evaluation.

The weight of the ESC and the battery of the propulsion system will be considered part of the Empty Weight of the aircraft.

R[9.3.1.4] The Electronic Speed Controller (ESC) must be commercial.

NC[9.3.1.4] Aircraft prohibited from participating in the competition.

VV[9.3.1.4] Evaluation of report and safety inspection.

R[9.3.1.5] Magnetic elements and junctions are not allowed in motor fasteners.

NC[9.3.1.5] Aircraft prohibited from flying with the battery, and flight attempt invalidated.

VV[9.3.1.5] Safety inspection

9.3.2 Transmission Boxes, Belts, and Propeller Shafts

Transmission boxes, belts, and propeller shafts are permitted. The rotation ratio between the motor and propeller can be different from one.

9.4 Cargo and Cargo Compartment

9.4.1 Gargo

Payload is the weight carried by the aircraft. The total payload consists of the sum of the weights of the plates (or cargo) plus the cargo support. The weight of the aircraft and the batteries of the propulsion system together with the ESC are NOT considered payload (See **Appendix 1**).

R[9.4.1.1] The payload must not contain lead parts.

NC[9.4.1.1] Non-compliance correction or the aircraft will be grounded.

VV[9.4.1.1] Safety inspection.

- R[9.4.1.2] The aircraft must not have ballast or any other lead part.
NC[9.4.1.2] Non-compliance correction or the aircraft will be grounded.
VV[9.4.1.2] Safety inspection.

- R[9.4.1.3] All cargo must be contained in a single cargo compartment, as per Subsection 9.4.2.
NC[9.4.1.3] Non-compliance correction or the aircraft will be grounded.
VV[9.4.1.3] Safety inspection.

- R[9.4.1.4] The payload must be a single assembled unit.
NC[9.4.1.4] Non-compliance correction or the aircraft will be grounded.
VV[9.4.1.4] Safety inspection.

- R[9.4.1.5] The payload structure must consist only of rigid elements. The geometry of the payload cannot be variable.
NC[9.4.1.5] Non-compliance correction or the aircraft will be grounded.
VV[9.4.1.5] Safety inspection.

It is suggested to assemble the payload as the combination of a “cargo support” plus the “cargo plates” (see example in **Appendix 1**).

- R[9.4.1.6] The cargo support + cargo assembly must be equal to or smaller than the volume of the compartment specified in Subsection 9.4.2.
NC[9.4.1.6] Non-compliance correction or the aircraft will be grounded.
VV[9.4.1.6] Safety inspection.

If specified by the team, the payload can be positioned inside the compartment with excess space, allowing the adjustment the aircraft’s CG.

- R[9.4.1.7] The payload must be properly secured in the cargo compartment (see Section 6.15) to prevent its movement during flight.
NC[9.4.1.7] Non-compliance correction or the aircraft will be grounded.
VV[9.4.1.7] Evaluation of report, safety inspection, and Runway Procedures.

- R[9.4.1.8] The payload must not structurally contribute to the stability of the aircraft structure or be part of it.
NC[9.4.1.8] Non-compliance correction, penalized by design changes as per Section 6.9, or the aircraft will be grounded.
VV[9.4.1.8] Evaluation of report and safety inspection.

In other words, structures whose stability is aided by contact with the cargo support or the cargo will not be accepted. Examples:

- Structures where attaching the cargo support on any face of the cargo compartment enables this cargo support to aid in structural stability. In principle, the structure must be stable and withstand flight loads by itself, i.e., even without the cargo support.
- Structures where simply placing the payload (or cargo support) allows designing a structure with fewer truss bars, i.e., it is not allowed for structural loads that should normally be transmitted by the aircraft structure to be applied and transmitted by the cargo support.
- Other cases, even if not mentioned in these examples, in which the Technical Committee judges that the cargo support or the payload is contributing to support the loads or is contributing to the stability of the structure, will be evaluated on a case-by-case basis.

The locking mechanism of the cargo support on the aircraft can be part of the cargo support being weighed as payload or of the aircraft structure and then be counted as empty weight.

- R[9.4.1.9]** The cargo access door opening device must be part of the aircraft, not the payload, and the door (or fairing) cannot be locked or attached to the cargo support, only to the aircraft structure.
- NC[9.4.1.9]** Non-compliance correction, penalized by design changes as per Section 6.9, or the aircraft will be grounded.
- VV[9.4.1.9]** Evaluation of report and safety inspection.

It is the responsibility of the teams to provide their own payload. The weight check will be performed after flight in the presence of the officials. The aircraft that does not allow the removal of the support for weighing will not have this weight included in the payload.

9.4.2 Cargo Compartment

The cargo compartment can be designed with whatever dimensions the team desires. However, within the compartment, it must be possible to place a standard block, to be provided by the competition, measuring 210 mm x 140 mm x 100 mm. The shape (or positioning) of the compartment is at the discretion of the team, and the block must be able to be inserted with clearance on all three faces. Adjustments with interference will not be accepted.

- R[9.4.2.1]** The cargo compartment must be large enough to fit a block of 210 x 140 x 100 mm with the axis orientation chosen by the team.
- NC[9.4.2.1]** Flight score zeroed, non-compliance correction, penalized by design changes as per Section 6.9 for permission for flight in future batteries.
- VV[9.4.2.1]** Post-flight inspection.
- R[9.4.2.2]** The cargo compartment must be single.
- NC[9.4.2.2]** Non-compliance correction, penalized by design changes as per Section 6.9, or the aircraft will be grounded.
- VV[9.4.2.2]** Safety inspection.

- R[9.4.2.3]** The cargo compartment must be fully enclosed, with cargo access doors that must be part of the aircraft.
- NC[9.4.2.3]** If verified before flight: non-compliance correction, penalized by design changes as per Section 6.9, or the aircraft will be grounded. If verified after flight: flight invalidated.
- VV[9.4.2.3]** Safety inspection and post-flight inspection.

Explaining further requirement **R[9.4.2.3]**, the airflow must not come into contact with the cargo or cargo support, i.e., any geometry defining the aerodynamic shape of the aircraft must be part of the aircraft, counted as the weight of the aircraft, and not as payload. If at the weighing moment it is found that the payload (all the load to be weighed, i.e., cargo and cargo support) has external components, the flight will be invalidated, and the team may make the necessary changes with penalties according to Section 6.9 regarding design changes.

9.5 Disassembly and Transportation Requirements

9.5.1 Aircraft Specifications

- R[9.5.1.1]** The aircraft must be designed in such a way that, when disassembled, including batteries, receiver, and other tools (screwdrivers, pliers, etc.) necessary for assembly and disassembly of the aircraft, it fits in a box shaped like a parallelepiped and can be easily carried by one person.
- NC[9.5.1.1]** Penalty as per Subsection 9.7.3.
- VV[9.5.1.1]** Post-flight inspection.

Payload and radio controller do not need to fit in the box.

- R[9.5.1.2]** The aircraft must be designed so that, from the transport box, only two people are capable of quickly assembling and disassembling it (recommended time, less than 2 minutes).
- NC[9.5.1.2]** Score as per Section 9.7.
- VV[9.5.1.2]** Safety inspection and post-flight inspection.
- R[9.5.1.3]** Magnetic elements and junctions must work only in axial traction.
- NC[9.5.1.3]** Aircraft prevented from flying on the battery and flight attempt invalidated.
- VV[9.5.1.3]** Runway procedures.

9.5.2 Aircraft Transport Box Specifications

- R[9.5.2.1]** The transport box must have an internal volume of no more than 0.036 m^3 and be a parallelepiped, with sides orthogonal to each other, and the Length (L), Width (W), and Height (H) measurements must correspond to the internal dimensions of the box (see **Appendix 6**).

NC[9.5.2.1] Penalty as follows:

If $\Delta V > 0m^3$ then $P_d = 50000 \times \Delta V$

If $\Delta V > 0.0015m^3$ then, in addition to the penalty applied, the flight is invalidated or the team may choose an additional penalty according to **Appendix 7, Section 7.2**.

Where:

P_d = penalty for exceeding the dimensional limit.

ΔV = excess volume over the maximum of this requirement (in cubic meters).

VV[9.5.2.1] Safety inspection.

If the team presents a box with a volume greater than the limit, it must make the necessary corrections to the box and the aircraft, being subject to the requirements of Section 6.9.

R[9.5.2.2] The internal volume of the transport box must be informed on the website www.aerocf.com.br and on the plant described in section Subsection 11.4.3.

NC[9.5.2.2] Aircraft prevented from participating in the competition.

VV[9.5.2.2] Submission of documents and report evaluation.

The design of access to the box's contents is at the discretion of the team.

R[9.5.2.3] The ratio between the largest and smallest internal dimensions of the transport box must be less than or equal to 5.

NC[9.5.2.3] Correction of non-compliance or aircraft prevented from participating in the competition.

VV[9.5.2.3] Submission of documents, report evaluation, and Safety Inspection.

R[9.5.2.4] The box must be made by the team and its walls must be free from deformations, as flat as possible, and with an intact external surface (without holes).

NC[9.5.2.4] The internal measurements considered will be the ones with the highest values, or those that determine the highest volume. These measurements will be used to validate requirement 9.5.2.3.

VV[9.5.2.4] Safety inspection.

R[9.5.2.5] After disassembly, the box lid must be completely closed, without needing assistance from team members to remain in position.

NC[9.5.2.5] The measured gaps will be counted in the box measurements.

VV[9.5.2.5] Safety inspection.

R[9.5.2.6] After disassembly, the box lid must be completely closed, without needing assistance from team members to remain in position.

NC[9.5.2.6] The measured gaps will be counted in the box measurements.

VV[9.5.2.6] Safety inspection.

- R[9.5.2.7] The lid, when closed, must be attached to the box in a transport configuration.
NC[9.5.2.7] Correction of non-compliance or flight invalidated.
VV[9.5.2.7] Safety inspection.

The team may use closing devices for the box lid.

- R[9.5.2.8] During box closing, no piece inside the box may break.
NC[9.5.2.8] If intentional, the flight will be invalidated. If accidental, the flight score will be zeroed.
VV[9.5.2.8] Safety inspection. If the judge suspects that the lid is too tight and may break a component, the box may be requested to be opened for verification.

9.5.3 Aircraft Junctions Specifications

- R[9.5.3.1] The lifting surfaces may be divided into up to 3 sections, i.e., a maximum of 2 junctions per surface.
NC[9.5.3.1] Aircraft prevented from participating in the competition.
VV[9.5.3.1] Document submission and report evaluation.

9.6 Electronics

9.6.1 Battery Pack

There is no minimum battery capacity required, but its sizing must be done to safely meet the loads required by the electrical systems with margin.

Battery sizing, as well as an electrical diagram and electrical sizing, must be demonstrated in the Electrical Design and Safety Assessment Report.

- R[9.6.1.1] Aircraft must not use systems with a Battery Eliminator Circuit that would allow the use of a single battery pack to power the motor and electrical systems.
NC[9.6.1.1] Correction of nonconformity or the aircraft will be prevented from flying.
VV[9.6.1.1] Evaluation of report and safety inspection.
- R[9.6.1.2] Electric motors must have a battery pack completely separate from other electronic components.
NC[9.6.1.2] Correction of nonconformity or the aircraft will be prevented from flying.
VV[9.6.1.2] Safety inspection.
- R[9.6.1.3] The motor battery must not be depleted during flight, similar to a fuel exhaustion.
NC[9.6.1.3] Flight invalidated.
VV[9.6.1.3] Post-flight inspection.

- R[9.6.1.4]** The team must submit to the website www.aeroct.com.br, along with the Electrical Design and Safety Assessment Report, the manufacturer's documentation of the motor battery(s) indicating their characteristics (voltage, charge, number of cells, and any other relevant information affecting motor power).
- NC[9.6.1.4]** Correction of nonconformity or the aircraft will be prevented from flying.
- VV[9.6.1.4]** Evaluation of report and safety inspection.

For details on the electrical installation of extensions manufactured by the team, see Section 6.21.

Additionally, all general battery requirements from Section 6.12 must be complied with for all batteries, whether for the control system or the propulsion system.

9.6.2 Flight Control Systems

The use of gyroscopes and any type of automatic control system **is allowed**.

- R[9.6.2.1]** Magnetic elements and junctions are not allowed in servomotor fastenings.
- NC[9.6.2.1]** Aircraft prevented from flying in the battery, and flight attempt invalidated.
- VV[9.6.2.1]** Safety inspection

9.7 Scoring - Micro Class

The score is the sum of the scores P_{MISSION} (described in Subsection 9.7.1) and the bonuses B_{AC} , B_{CF} , B_{MV} , and B_{MD} (described in Sections 9.7.4, 9.7.5, 9.7.6, and 9.7.7). The sum of other penalties such as lateral escape (Subsection 10.1.8), among others (**Appendix 7**), if applicable, will be done in the final computation of the team's score.

9.7.1 Mission Score [per flight battery]

Micro Class aircraft will be scored as follows:

$$P_{\text{MISSION}} = FPV \times FTM \times 250 \times CP^{0.4} \times \left[\frac{0.66}{1 + e^{\left(\frac{1.75 - EE}{0.6} + 0.3\right)}} + 0.4 \right] \quad (9.1)$$

Where: CP is the payload in kg; EE is the structural efficiency of the aircraft ($\frac{CP}{PV}$); PV is the empty weight of the aircraft in kg; FPV is the Empty Weight Prediction Factor (Subsection 9.7.2); FTM is the score correction factor for mission time (Subsection 9.7.3).

9.7.2 Empty Weight Prediction [per flight battery]

With the intention of encouraging teams to improve their engineering processes and to build and thoroughly test their official aircraft well in advance of the Competition, a factor called Empty Weight Prediction Factor (FPV) has been inserted, calculated by the following formula:

$$FPV = 1.05 - 10 \times \left(\frac{PV_{\text{EXPECTED}} - PV_{\text{EXECUTED}}}{PV_{\text{EXPECTED}}} \right)^{2.2} \quad (9.2)$$

The minimum value of FPV is 0.95. If the calculated value for the team is lower than this value, the minimum FPV will be used.

R[9.7.2.1] The expected empty weight must be presented on the website www.aerocf.com.br for both missions.

NC[9.7.2.1] The minimum FPV will be automatically applied.

VV[9.7.2.1] Document submission and report evaluation.

The value will be calculated according to the executed mission.

It is suggested that this value also be clearly presented in the Design Report and Three-View Technical Drawing.

9.7.3 Mission Time [per flight battery]

A score correction factor will be calculated for each battery based on the total mission time of the aircraft in seconds, according to the equation below:

$$FTM = \max \left(0.1 ; \frac{1}{1 + \exp \left(\frac{t-261}{33.8} - 6.1 \right)} \right) \quad (9.3)$$

Where \max is the function that results in the maximum value between the two inputs; \exp is the function that results in the exponential of the input value; t is the total mission time in seconds.

This equation results in a factor close to 1 up to about 300 seconds (5 minutes), after which the factor begins to degrade, as the mission time deviates from rule **R[9.5.1.2]**. At around 7 minutes, the factor already approaches 0.8, penalizing flight score (Subsection 9.7.1) on the battery. From approximately 9 minutes, the equation already uses its minimum value, 0.1.

9.7.4 “Accuracy” of Payload Bonus [per flight battery]

Additional points will be added based on the accuracy of the payload capacity prediction. The resulting score of this “accuracy” is calculated by the following formula:

$$P_{AC} = 30 - 830 \times \text{abs} \left(\frac{CP_{EXPECTED} - CP_{EXECUTED}}{CP_{EXPECTED}} \right)^{1.75} \quad (9.4)$$

as long as the expression has a positive value. Otherwise, the score will be zero (0).

Where: P_{AC} Accuracy score; $CP_{EXPECTED}$ Expected payload (obtained from the payload capacity graph - Section 11.5); $CP_{EXECUTED}$ Actual payload; abs is the absolute value (modulus) function that returns the square root of the square of the real number.

9.7.5 Reliability Bonus [single bonus]

In order to benefit teams whose design has great reliability and manages to make more than one flight with a significant payload, the following bonus will be awarded:

$$B_{CF} = 20 \times \left[1 - \left(5 \times \frac{P_{B1} - P_{B2}}{P_{B1}} \right)^2 \right] \quad (9.5)$$

As long as the expression has a positive value. Otherwise, the score will be zero (0). Where P_{B1} is the total score of the best test battery; P_{B2} is the total score of the second best test battery.

9.7.6 Minimum Volume Box Bonus [single bonus]

Teams that perform a valid flight in the competition will have their Transport Boxes measured. The Volumes will be arranged in increasing order, from smallest to largest, and the 5 teams with the smallest volume will be awarded according to the following score:

$$B_{MV} = 20 - [(n - 1) \times 4] \quad (9.6)$$

Where n is the position in the list of smallest Transport Box Volumes.

9.7.7 Bonus for assembly and disassembly process validation [one-time bonus]

With the aim of encouraging teams to train, verify, and validate their aircraft assembly and disassembly processes, a bonus of **15 points** will be given to teams that submit a video demonstrating all the processes described in the “Assembly and Disassembly Process + Aircraft in the Box” layout defined in Subsection 11.4.3.

The video must be recorded in a well-lit location and in such a way that all processes are visible in the final video. The team must record in 2 separate phases, of assembly and disassembly, and then edit/merge the videos before official submission.

- R[9.7.7.1] The assembly process must be recorded on a workbench, completed within **180 seconds**, and follow the requirements defined in Subsection 9.2.3, with the exception of adding 10 s after announcing the end of the assembly for any changes to the assembly.
- NC[9.7.7.1] Team does not receive full 15-point bonus.
- VV[9.7.7.1] Evaluation of assembly and disassembly video.

- R[9.7.7.2] The disassembly process must be recorded on a workbench, completed within **120 seconds**, and follow the requirements defined in Subsection 9.2.2, with the exception of adding 10 s after closing the disassembly box for any changes to the disassembly.
- NC[9.7.7.2] Team does not receive full 15-point bonus.
- VV[9.7.7.2] Evaluation of assembly and disassembly video.

- R[9.7.7.3] The assembly and disassembly video must be submitted by the date specified in the **Appendix 9**.
- NC[9.7.7.3] Team receives 0 bonus points.
- VV[9.7.7.3] Evaluation of assembly and disassembly video.

10. Mission Requirements - All Classes

10.1 Flight Competition

10.1.1 General Flowchart

In order to participate in the Flight Competition, the team must have previously flown the aircraft.

The Flight Competition is carried out according to the diagram below, each block will be detailed in the next items.



Figura 10.1: Flight Competition Flow.

The operations flowchart shown above may vary slightly whether the team is from the Regular, Micro, or Advanced Class, see **Appendix 10** for more details.

10.1.2 Team Workbenches

Throughout the flight competition period, teams will be allocated to the “Teams Tent”. In this tent, each team will be entitled to only **one workbench**. Even if the team has more than one aircraft, the workbenches are limited to only one per team. At the workbenches, teams may perform any tasks they need to. It is the team’s responsibility to keep its workbench and surroundings **ALWAYS CLEAN**. Remnants of materials, parts, etc., cannot under any circumstances be left on the ground. Trash bags will be provided to the teams. All

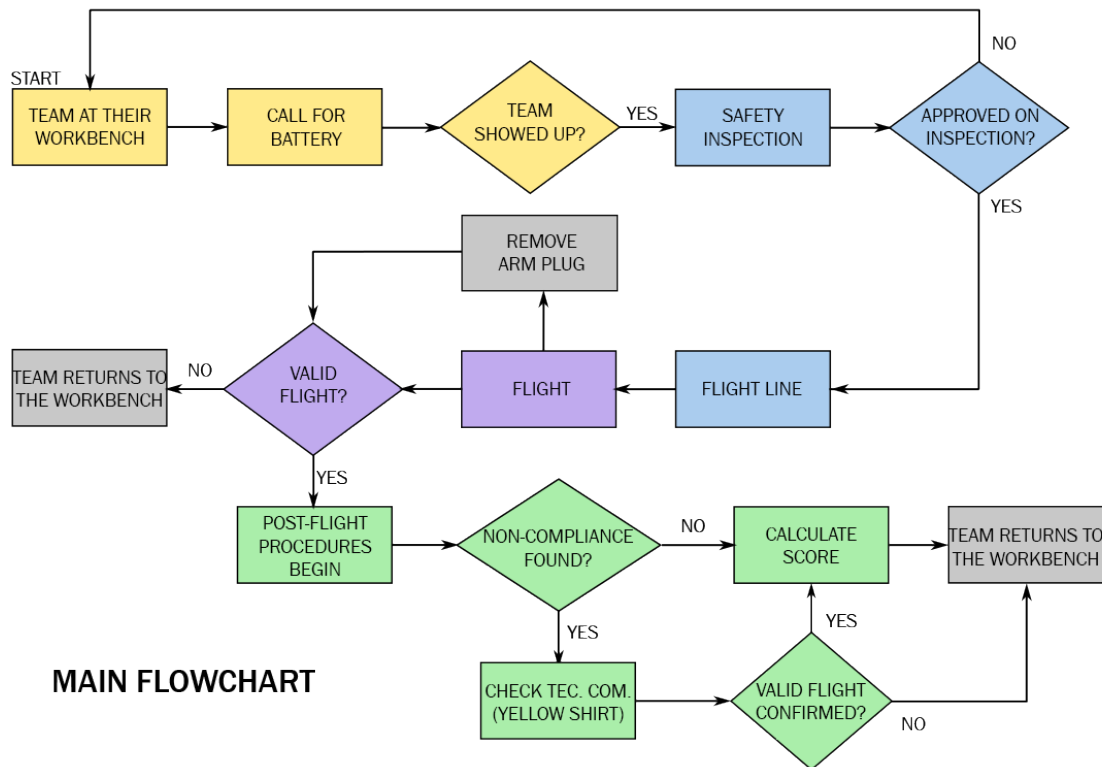
of this is part of a campaign against FOD (or *Foreign Object Damage*). The presence of these foreign objects (FODs) on the runway or aircraft operation area can cause serious damage to aircraft engines due to ingestion of these foreign objects. **Due to the competition being held in an active airport, it is extremely important for teams to be aware of this fact.**

10.1.3 Call for Inspection

Teams will be called three (3) times to present themselves for safety inspection, with 5-minute intervals (reference value, which may vary depending on the competition progress) between each call.

R[10.1.3.1] The team must present itself for safety inspection when called.

NC[10.1.3.1] Test battery is lost if not present by the third call.

VV[10.1.3.1] Safety inspection.

It is the team's responsibility to pay attention to the calls. Teams from **all classes** will be called in direct order of score. For the order of teams, the most updated score sheet at the moment that the call for a test battery begins will always be considered.

R[10.1.3.2] A team's safety inspection after the third call cannot be started after the first call of any team for the next battery in the same class or after the declaration of the end of the flight day.

NC[10.1.3.2] Test battery is lost.

VV[10.1.3.2] Safety inspection.

10.1.4 Safety Inspection

The aircraft must undergo a safety inspection before each flight. The safety inspection does not penalize points but can prevent the team from flying.

R[10.1.4.1] Teams must present themselves for inspection **at the safety inspection tent** with the aircraft assembled and the cargo compartment loaded.

NC[10.1.4.1] Noncompliance correction or the aircraft will be prohibited from flying.

VV[10.1.4.1] Safety inspection.

R[10.1.4.2] A maximum of two (2) team members + pilot must be present at the inspection (if the pilot is not part of the team).

NC[10.1.4.2] Excess members must leave. If the team persists, penalties as per **Appendix 7, Section 7.3**

VV[10.1.4.2] Safety inspection.

If the pilot is part of the team, only (2) members will be accepted (the pilot and another team member).

The use of the Competition scale under any circumstances is not allowed. **The scale will be for the exclusive use of the judges.** The same applies to other Competition equipment.

All safety items will be checked, and if necessary, corrections indicated by the judges may be made. Non-compliance with safety items prevents the aircraft from flying. If very large repairs to the aircraft are necessary, and the judges foresee that the team will take a long time in the inspection (much longer than the average, compared to other teams), it may be decided that the team returns to their workbench and prepares for the next test battery. As this type of prediction is difficult to make, the judgment of the Technical Committee will be taken as final, and cannot be questioned by any team.

Only Technical Committee members (yellow shirt) can decide to fail an aircraft in the safety inspection.

As the Competition progresses, the Technical Committee may choose to be more flexible with inspection time, especially in the last open battery.

In the document **SAE AeroDesign Good safety practices handbook**, a copy of the safety inspection form will be provided where the items that make up the inspection can be checked. It is suggested that teams adopt this form for their own use, in order to perform their own check at their workbench, and attend the inspection prepared and ready for flight.

The same document contains a series of known safety recommendations and solutions that may be approved more easily in the safety inspection.

The safety inspection will consist of the items present in the safety checklist in order to ensure compliance with all requirements in these rules relevant to this procedure, but other items may also be checked as necessary. If the referees deem that the airplane is not safe for flight due to non-compliance with the checklist items, the flight may not be authorized until all required items are addressed.

R[10.1.4.3] The team must execute all changes requested by the judges and referees.

NC[10.1.4.3] Noncompliance correction or the aircraft will be prohibited from flying.

VV[10.1.4.3] Safety inspection.

Some corrections will be required for the current or next test battery, as appropriate.

10.1.5 Flight Waiting Line

In this phase, teams will be lined up, waiting to fly. The order of the line will be determined according to the order of teams that completed the safety inspection. For the last battery, the Technical Committee may control the flight line order according to the descending score order of the teams.

Micro teams may choose to wait as long as they wish, allowing other aircraft to pass ahead in line. However, if all Micro teams are ready in the flight line, then Micro teams may no longer choose this wait.

R[10.1.5.1] Teams must not work on the aircraft while in the waiting line.

NC[10.1.5.1] Team loses test battery.

VV[10.1.5.1] Flight line.

Due to atmospheric changes during the team's stay in the line, they may modify the cargo loaded to better suit the conditions near the time of flight. However, some conditions are necessary for cargo modifications while the aircraft is in the flight line:

R[10.1.5.2] Cargo modifications cannot be performed without the supervision and authorization of a judge.

NC[10.1.5.2] Team loses test battery.

VV[10.1.5.2] Flight line.

R[10.1.5.3] There must be **at least three (3)** teams ahead of you in the flight line (excluding the one already on the runway for takeoff).

NC[10.1.5.3] Team loses test battery.

VV[10.1.5.3] Flight line.

R[10.1.5.4] The team must finish the cargo modification before their turn to enter the runway.

NC[10.1.5.4] Team loses test battery.

VV[10.1.5.4] Flight line.

R[10.1.5.5] Only 2 team members plus the pilot can wait with the aircraft in the flight line.

NC[10.1.5.5] Non-compliance correction or the team loses test battery.

VV[10.1.5.5] Flight line

The flight line is located in a place susceptible to sun and rain. It is the team's responsibility to provide ways to protect the aircraft and members, without using more team members. Teams must follow the instructions given by the judges and especially by the members of the Technical Committee (yellow shirts) during their time in the flight line. Only one member of the Technical Committee can interfere with the order of this line.

10.1.6 Valid Takeoff

R[10.1.6.1] The aircraft must take off within three (3) minutes if it is in the Regular Class, four (4) minutes if it is in the Micro Class, or five (5) minutes if it is in the Advanced Class.

NC[10.1.6.1] Team loses test battery.

VV[10.1.6.1] Runway.

R[10.1.6.2] The aircraft must take off in three (3) attempts or fewer for the Advanced, Micro, and Regular Classes.

NC[10.1.6.2] Team loses test battery.

VV[10.1.6.2] Runway.

If the team is not ready for flight when requested, They will lose their turn, having to wait until the next test battery to fly. Interruptions may occur (other aircraft in operation at the airport), causing the attempt to be interrupted. A new countdown will restart after the runway is cleared, meaning the timers will be reset.

R[10.1.6.3] In cases of interruption, the team must not touch the aircraft or leave the runway until the interruption ends and the timers restart.

NC[10.1.6.3] The team loses the test battery.

VV[10.1.6.3] Runway.

R[10.1.6.4] The aircraft must comply with the Specific Requirements for Regular, Advanced, and Micro Classes, respectively.

NC[10.1.6.4] Flight invalidated.

VV[10.1.6.4] Runway procedures. There will be markings delimiting the runway boundaries and referees.

Takeoff lines, as well as flags and obstacles, will be marked by the track judges of the Technical Committee. These lines are the official takeoff demarcation lines, regardless of precisely meeting the distance requirements above.

The figures below show the landing gear wheels at the last instant of ground contact and after the plane has fully taken off (being supported by the wings). The line represents the takeoff limit. The flight is considered valid if the aircraft is clearly airborne before the line. If the aircraft does not take off until the limit of the distance (figure on the right), the flight is considered invalid.



Figura 10.2: Example of valid and invalid takeoff.

R[10.1.6.5] The aircraft must start the takeoff run with the main landing gear on the line marking the beginning of the runway.

NC[10.1.6.5] The team will be asked to correct the position of the aircraft, and if they don't, the flight will be invalidated.

VV[10.1.6.5] Runway.

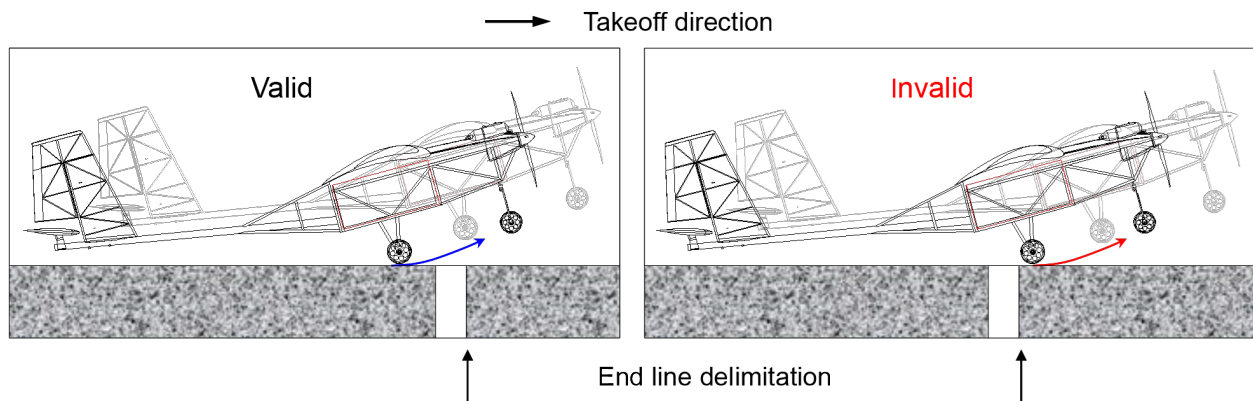
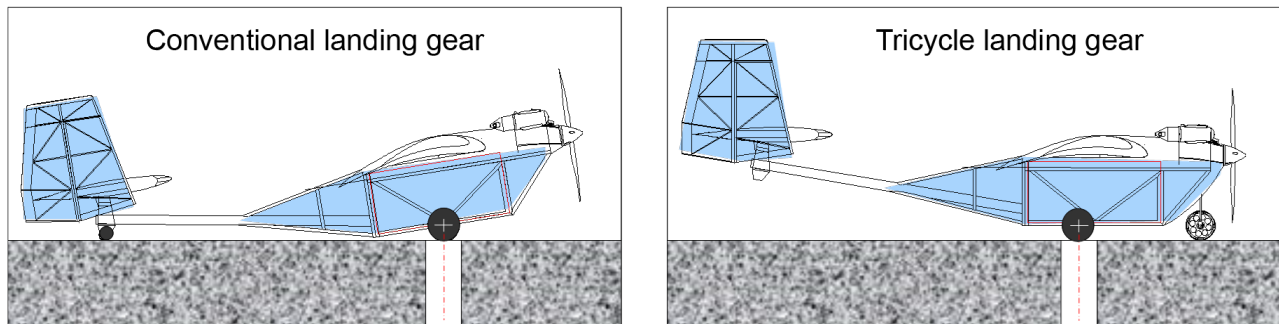

The center of the wheel of the main landing gear must be aligned with the center of the line

Figura 10.3: Start of takeoff run. The center of the main gear wheel must be positioned aligned to the center of the line.

R[10.1.6.6] The aircraft must not touch the ground after takeoff and surpass the takeoff mark (obstacle for Regular and Advanced, and limits of the takeoff platform or 10 m mark for Micro) until the moment of landing.

NC[10.1.6.6] Flight invalidated.

VV[10.1.6.6] Runway.

R[10.1.6.7] The aircraft must have the motor at idle and free from external interference at the start of the takeoff run for the Regular and Advanced Classes. For the Micro Class, only one person may hold the aircraft as per requirement **R[9.2.4.1]**.

NC[10.1.6.7] Flight invalidated.

VV[10.1.6.7] Runway.

In other words, only one person will be allowed to hold the aircraft in the Micro Class. In none of the Classes, it will be allowed to use any device not belonging to the aircraft for the run to start with the motor already at maximum power. For the Regular and Advanced Classes, the aircraft must be free or stopped by its own means at the moment the pilot accelerates to start the run.

The takeoff direction will be chosen to prioritize takeoff into the wind, but always considering the safety of the people present in the competition environment. In this case, the team has no right to challenge the judges regarding the takeoff direction and initial position of the run.

Details of the takeoff piloting procedure will be specified in a briefing with all pilots and team captains before the first flight in the competition.

The runway width is generally about 10 m, but more details will be effectively shown at the competition.

Note: Aircraft in general, taking off close to their maximum limit, may after takeoff skim the grass during ascent. This event may eventually not invalidate the flight provided that during this low pass the aircraft visibly does not touch the ground or have its attitude or direction modified due to this touch. When the aircraft only skims the grass, it generally does so without the slightest variation in its flight trajectory. The decision on the validation or not of the flight will be exclusively up to the Track Judges (in yellow) or members of the Technical Committee (yellow shirts) who have witnessed the fact.

10.1.7 Airborne Segment - Standard Circuit

R[10.1.7.1] The aircraft, taking off within the maximum distance, must make at least one 360-degree turn and then land.

NC[10.1.7.1] Flight invalidated.

VV[10.1.7.1] Runway.

There is no limit to how many turns the plane can make before landing, as long as there is no fuel starvation and it does not violate the airspace defined before the competition.

For Micro Class teams, there is a “minimum box” for this 360-degree turn, as per requirement R[9.2.4.2].

Note: The available airspace will be that regulated by the document **Operational Procedures - SAE AeroDesign** and is based on safety standards for “model aircraft” flight. These must be strictly respected. Flight outside the defined limits may result in team disqualification. The definition of the “flight box” can be seen in the **Operational Procedures** and will also be done during the briefing before the Flight Competition.

10.1.8 Valid Landing

R[10.1.8.1] The plane must land (touch the ground and start rolling) within the area designated as the landing zone with **100 meters** in length.

NC[10.1.8.1] Flight invalidated.

VV[10.1.8.1] Runway.

In other words, the initial touch of the plane on the ground must be within the designated landing area, but the roll until the stop may be beyond the runway limits. If the plane exceeds the longitudinal limit of the landing area, it must do so while rolling, i.e., with at least one of the main landing gear wheels touching the ground. A crash invalidates the attempt. If the aircraft also manages to stop within the limit of requirement R[10.1.8.1], there may or may not be a specific bonus, depending on the Class (Regular, Advanced, or Micro) of the competition.

R[10.1.8.2] The plane must not perform touch-and-goes.

NC[10.1.8.2] Flight invalidated.

VV[10.1.8.2] Runway.

If the pilot needs to go around, they must do so with the aircraft still in the air.

R[10.1.8.3] The aircraft must not leave the runway laterally while in the landing zone of requirement R[10.1.8.1].

NC[10.1.8.3] Penalty according to **Appendix 7, Section 7.3**.

VV[10.1.8.3] Runway: for it to be considered valid, the aircraft must have at least half of the number of wheels within the runway.

This penalty is only valid for side excursions **on landing**, not being valid under any circumstances during takeoff. In this case, the flight is invalidated.

The permitted width for touch, run, and stop is generally about 10 m, but more details will be shown at the competition.

“Zigzags”, “stall turns”, and oscillating landings (touch-and-go or bouncing landings) are allowed but not recommended.

Track judges will judge based on this criterion. The word of the judge must be final and irrevocable. In cases considered more critical, it is advisable to consult the Technical Committee members to obtain a final decision.

R[10.1.8.4] No team member should enter the runway until the aircraft has come to a complete stop.

NC[10.1.8.4] Flight invalidated.

VV[10.1.8.4] Runway.

R[10.1.8.5] No team member should touch the aircraft after landing before the judge’s authorization.

NC[10.1.8.5] Flight invalidated.

VV[10.1.8.5] Runway.

It is suggested to stay at least two meters away from the plane until the track judge has authorized it.

10.1.9 Standard Flight (fully valid flight)

A flight will be considered valid when the takeoff is valid (**Subsection 10.1.6**), the standard circuit is performed (**Subsection 10.1.7**), and the landing is valid (**Subsection 10.1.8**). The declaration that the Standard Flight was successfully performed will be made by the track judges. However, the flight will only be declared fully valid after checking the aircraft’s condition after landing (**Subsection 10.1.10**). This verification of the aircraft’s condition will be carried out by referees dedicated to this task, in order to expedite the runway procedures and to enable the verification of the aircraft’s condition with more time, allowing for a more rigorous check. It is important to emphasize that after the flight, the aircraft must always be accompanied by a referee. It is the team’s responsibility to ensure the structural integrity of the aircraft on the route between the point of touchdown on the runway and the location of the post-flight inspection since there will be no distinction between damage occurring during takeoff, flight, landing, and movement to the post-flight inspection for the purposes of this more rigorous inspection. Extreme cases occurring during the movement between the runway and inspection that have occurred due to force majeure will be evaluated by the technical committee based on the report of the referee accompanying the aircraft, and the committee will have the final word.

R[10.1.9.1] No repairs should be made until the team is allowed to return to their workbench.

NC[10.1.9.1] Penalty according to **Appendix 7, Section 7.3**.

VV[10.1.9.1] Post-flight inspection.

10.1.10 Aircraft Condition Inspection after Flight

For the inspection of the aircraft condition after flight, its components will be separated into four categories:

- Primary components: components whose integrity is necessary for safe flight (see **Appendix 2**);
- Non-primary components: components whose integrity does not affect safety and flight, but only the aircraft's performance (see **Appendix 2**);
- Wheel: only the rotating parts of the landing gear are considered wheels. Axles, even if they rotate, will not be considered as wheels;
- Propeller.

If the team's aircraft has any component not listed in **Appendix 2**, it is suggested to inquire via www.aerocf.com.br. Otherwise, the deliberation on which category a component falls into will be made during the competition and cannot be contested.

R[10.1.10.1] The aircraft must take off, land, and arrive at the post-flight inspection with all original parts (i.e., those defined in the design).

NC[10.1.10.1] Flight invalidated.

VV[10.1.10.1] Runway and post-flight inspection.

R[10.1.10.2] The aircraft must land and arrive at the post-flight inspection with the same parts it took off with.

NC[10.1.10.2] Flight invalidated.

VV[10.1.10.2] Runway and post-flight inspection.

Therefore, discarding parts during takeoff (or before it) or at any other time during the flight and during movement after the touchdown until the post-flight inspection is not permitted.

R[10.1.10.3] All Primary Components must remain fixed, intact, and without permanent deformations.

NC[10.1.10.3] Flight invalidated.

VV[10.1.10.3] Runway and post-flight inspection.

R[10.1.10.4] All Non-Primary Components must remain fixed, intact, and without permanent deformations.

NC[10.1.10.4] Penalty according to **Appendix 7, Section 7.3**.

VV[10.1.10.4] Runway and post-flight inspection.

R[10.1.10.5] Wheels must remain fixed, intact, and without permanent deformations.

NC[10.1.10.5] Penalty as per **Appendix 7, Section 7.3**.

VV[10.1.10.5] Runway and post-flight inspection. The aircraft will be considered able to roll normally if when pushed there is no slippage between the wheels and the ground.

Propellers may break upon contact with the ground.

The final decision on flight invalidation or not will always be made by the judges who are verifying the aircraft's integrity after the flight. The same criteria and rigor will be adopted for all teams regarding the interpretation of this section of the regulation. The decision of this judge will be considered final and irrevocable. In cases of doubt, a forum composed of members of the Technical Committee will be formed to make a decision on the flight validation. Once the decision is made, the same standard will be adopted for other cases where similar situations occur.

After this verification, the aircraft undergoes a series of procedures described below. If any problems are detected in the aircraft's integrity during any of these procedures (e.g., cargo removal, weighing, etc.), a new integrity assessment will be performed. The team will only have its flight effectively validated when all procedures are executed and the aircraft is cleared to return to its workbench.

10.1.11 Removal of Cargo

The team will remove the cargo from the aircraft for weighing. For the Regular Class, see **Subsection 7.7.7** regarding bonuses. For the Advanced Class, see **Subsection 8.10.6**. For the Micro Class, see requirements **R[9.2.2.1]** and **R[9.2.2.2]**.

R[10.1.11.1] The aircraft's cargo compartment must not be opened without the authorization of a judge or referee.

NC[10.1.11.1] Flight invalidated.

VV[10.1.11.1] Runway and post-flight inspection.

10.1.12 Rapid Cargo Removal (Regular and Advanced)

Advanced teams wishing to count the motor battery as payload must remove the battery (which must be in a separate compartment from the cargo) before rapid cargo removal.

In categories where this bonus exists, the procedure adopted is as follows:

The aircraft is positioned within the square, measuring 3m by 3m, drawn on the ground so that the center of its cargo compartment coincides with the center of the square. In two corners of the square, a smaller square will be demarcated, where the team member who will perform the rapid cargo removal must position the cargo (Cargo + Cargo Support) carried by the aircraft.

The team is free to choose which of the smaller squares will be used.

The aircraft can be oriented (rotated) so that its position is more favorable for cargo removal. This position can be defined by the team.



Figura 10.4: Example of aircraft positioning within the square.

The team members (up to two) chosen to perform this cargo removal stand outside the square until ordered by the timing officials (The goal is to have two officials timing the cargo removal and separation. In this case, the valid time will be the average of the determined times). The official(s) will time until the team member(s) performing the cargo removal leave the square and give the stop order. The official(s) will then evaluate if the removal was valid for scoring.

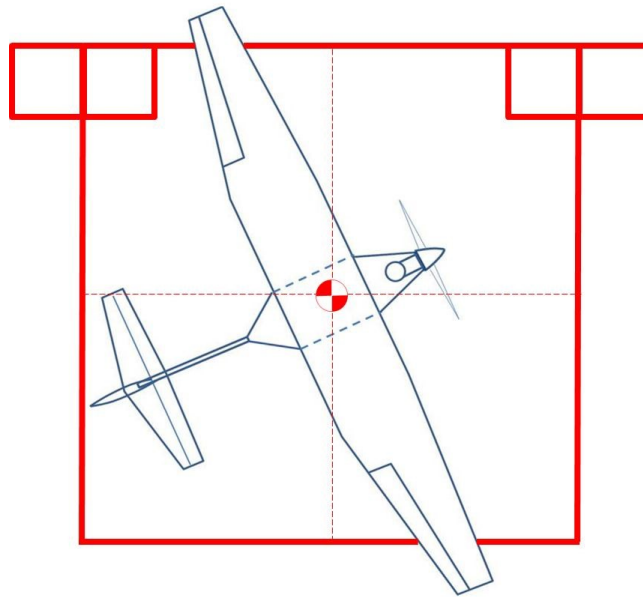

Figura 10.5: Example of cargo removal.

R[10.1.12.1] The cargo support and/or the cargo itself **MUST NOT** be destroyed in this operation, as they must be able to be used again.

NC[10.1.12.1] Rapid cargo removal bonus zeroed.

VV[10.1.12.1] Post-flight inspection.

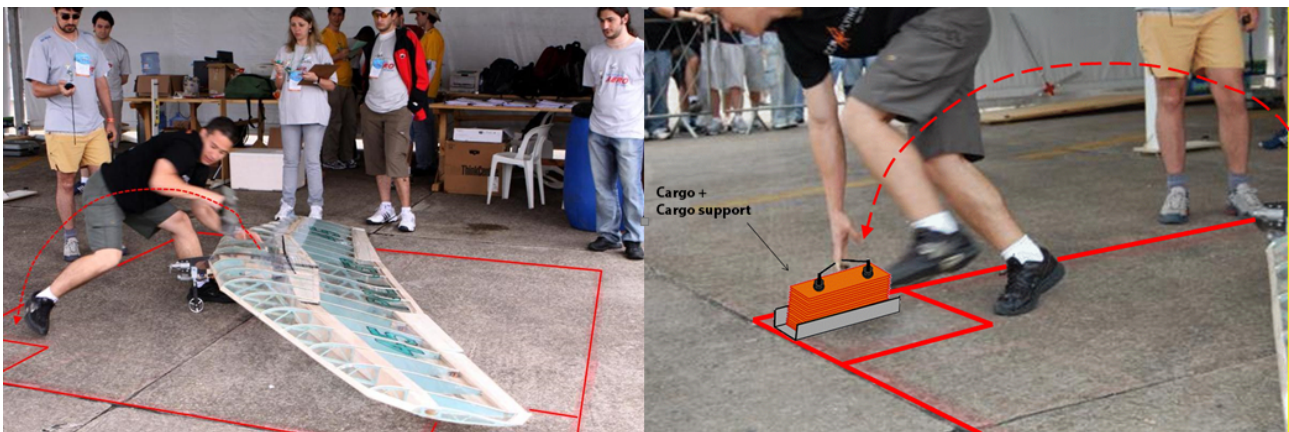
R[10.1.12.2] The aircraft must not suffer damage during cargo removal.

NC[10.1.12.2] Rapid cargo removal bonus zeroed.

VV[10.1.12.2] Post-flight inspection.

R[10.1.12.3] Cutting tools must not be used to perform the rapid cargo removal process.

NC[10.1.12.3] Rapid cargo removal bonus zeroed.

VV[10.1.12.3] Post-flight inspection.

Finally, in order to maintain productivity in the post-flight station during the competition, disassembly of primary components for cargo removal as per R[10.1.12.4] will not be allowed.

R[10.1.12.4] Primary elements (Appendix 2) must not be disassembled for cargo removal.

NC[10.1.12.4] Team does not receive cargo removal bonus (if applicable) and will incur a 20-point penalty on the test battery.

VV[10.1.12.4] Post-flight inspection.

10.1.13 Weighing Process

Aircraft in the Advanced, Regular, and Micro Classes will weigh the empty aircraft and the paid cargo separately.

Invalidated flights will not be weighed.

No team will be granted authorization to weigh the aircraft and/or cargo outside the normal test battery sequence.

10.1.14 Dimensional Verification, Cargo Compartment, and Transport Box

Aircraft in the Regular, Advanced, and Micro Classes that have valid flights will undergo dimensional verification process as described in the following sections:

- Regular Class: **Sections 7.2 and 7.4.1**
- Advanced Class: **Subsection 8.10.3**
- Micro Class: **Sections 9.5 and 9.4.2**

It is the responsibility of the teams to ensure that the external and internal dimensions of the aircraft comply with the design and with this Regulation, so that penalties and flight invalidations are not applied, as applicable and depending on the Class in which the team competes.

10.1.15 Extraction of Data from the Acquisition System [Advanced Class Only]

Data recorded in the acquisition system must be removed from the aircraft and provided to the Technical Committee for analysis (Section 8.8). Depending on the progress of the competition, data analysis may not be performed immediately.

10.2 Competition Structure and Test Batteries

The Flight Competition is structured in test batteries, where each test battery corresponds to one attempt that each team will have to fly.

Each battery will have a classification structure composed of:

1. Minimum Payload (CP) flown in any previous valid flight.
2. Placement in the score based on the last available score sheet, provided the team has at least one previous valid flight.
3. Minimum number of teams per test battery.

The flowchart below summarizes the classification from the fourth test battery onward:



Figura 10.6: Battery Classification Flowchart

Meanwhile, Tabela 10.1 presents the values considered per test battery for minimum payload, position (already considering the filtered list of teams with valid flight), and minimum number of teams per test battery.

Competition Class		Competition Test Battery						
		1	2	3	4	5	6	7 and above
Regular	CP [kg]	0	0	0	5	6	7	8
	Min. Number of Teams	-	-	-	25	20	15	15
	Position	-	-	-	10	10	10	10
Advanced	CP [kg]	0	0	0	0	0	0	0
	Min. Number of Teams	-	-	-	-	-	-	-
	Position	-	-	-	-	-	-	-
Micro	CP* [kg]	0	0	0	0	0.5 PV	0.6 PV	0.7 PV
	Min. Number of Teams	-	-	-	10	9	8	7
	Position	-	-	-	5	5	5	5

Tabela 10.1: Test Battery Structure in the Competition

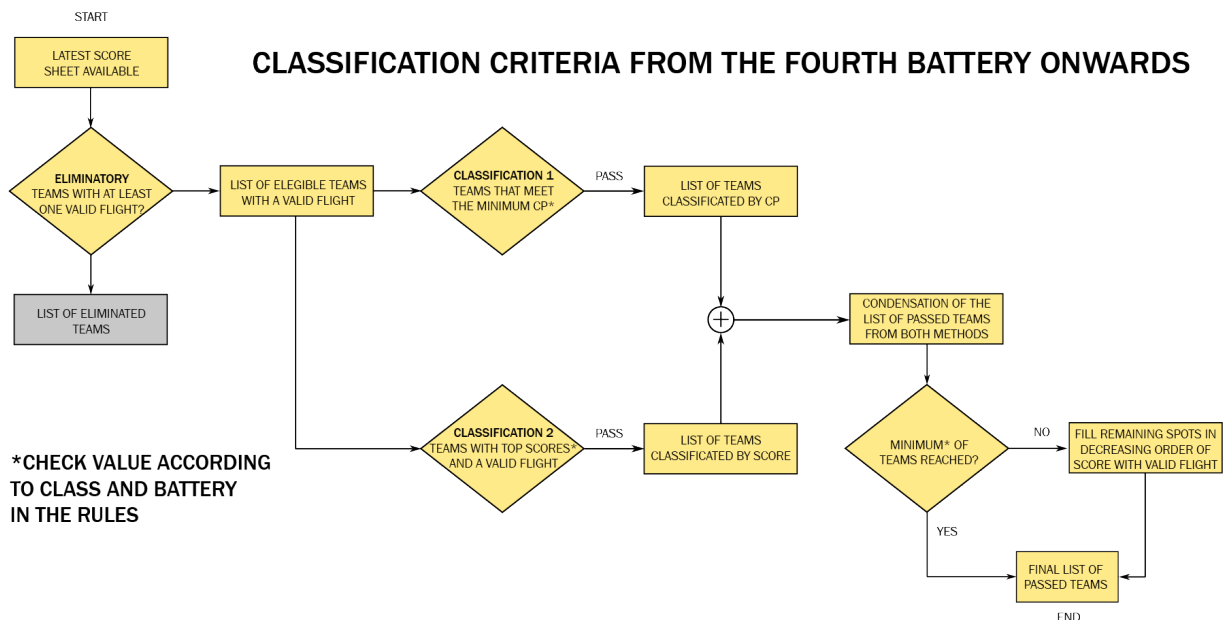
Below are some details regarding battery dynamics:

- When the minimum payload is 0 kg, it is understood that it is not necessary to have a valid flight prior to participating in the battery, but for flight validation, Rule R[10.2.1.1] must be respected.
- There is no maximum payload to be considered in the batteries.
- The payload flown in any battery (with valid flight) is sufficient for demonstrating the minimum payload (Example: if a Regular Class team performs a valid flight with 8 kg in the first battery, they are eligible to fly all other batteries of the competition).
- From the fourth battery onwards, the top-ranked teams from the filtered list with valid flights are eligible to fly according to **Table Tabela 10.1**, regardless of the minimum load.
- To fly a test battery, the team must have validated a flight with the minimum CP indicated for that battery or be among the top-ranked teams according to **Table Tabela 10.1**. If the number of teams meeting this criterion is less than the minimum indicated for that battery, then the list of teams eligible to fly will be completed up to the established minimum number in descending order of **SCORE IN VALID FLIGHT** until the previous battery.

Finally, regardless of **Tabela 10.1**, the last battery of the competition is subject to **Section 10.2.3**.

10.2.1 Minimum Payload for Valid Flight

R[10.2.1.1] To consider a flight valid, the battery score must be greater than zero and the aircraft must carry a minimum mass of **5.0 kg** (Regular Class), **5.0 kg** (Advanced Class for the Performance Campaign), **0 kg** (Advanced Class for the Systems Campaign) or **0.3 PV kg** (Micro Class).

NC[10.2.1.1] Flight invalidated.

VV[10.2.1.1] Post-flight inspection.

An invalidated flight does not have its score considered. Additionally, the completion of valid flights will be a criterion for classification for next year's competition, see **Registration Rules for SAE BRASIL AeroDesign 2024**.

10.2.2 Considerations on Test Batteries

Demonstration flights of any nature, even from teams that did not qualify, **are prohibited** due to the large number of participating teams. The intention is to carry out as many batteries as possible. There will be no flights even after the competition, as at this time all technical committee, judges, and referees are dedicated to finalizing the scores for the awards ceremony, unable to guarantee the safety of these flights.

10.2.3 Final Test Battery (top-ranked teams)

It is not always possible to complete full batteries or all categories at the end of the competition, i.e., with all qualified teams. Therefore, to ensure maximum competitiveness among the leading teams, there may be a test battery among the finalists. The number of teams admitted to this battery will be determined by the competition organizers.

Alternatively, the Technical Committee may adopt a final battery performed in direct order of scoring (1st place flies first and so on) in order to carry out flights to the highest possible number of teams. In this case, the competition may be finished at any time, with no recourse from the teams.

However, there is no guarantee from the Technical Committee of the event that this battery will be carried out. The available time for the end of the competition will be the criterion used for this decision.

It is worth noting that the flight competition may end in the middle of Sunday afternoon at a time set annually, depending on the logistics for closing and awarding. Thus, no aircraft will take off after the time stipulated by the Technical Committee.

10.3 Changes and Repairs

The original aircraft design, as presented in the Design Competition, may be repaired during the course of the competition. However:

R[10.3.0.1] The aircraft must use original parts or be replaced by identical spare parts to the originals.

NC[10.3.0.1] Non-compliance correction, or penalty for project alteration according to **Section 6.9** or the aircraft will be prevented from flying.

VV[10.3.0.1] Safety inspection and post-flight inspection.

The motors of the top five teams in the Competition (Regular Class) may be disassembled, reviewed, and checked for tampering at any time during or after the competition.

The replaced parts mentioned above must be identical to the original ones, except for the propeller. Any deviation from the original design must be reported to the Technical Committee as indicated in **Section 6.9**.

R[10.3.0.2] Repairs to primary components must be reported to the inspector during the safety inspection.

NC[10.3.0.2] Team penalized according to **Appendix 7 Section 7.2**.

VV[10.3.0.2] Safety inspection.

Changes may only be made with the judges' permission to meet changes requested by them during the safety inspection.

Note: Any alteration (due to repair or not) in relation to the original design must be declared, authorized, and eventually subject to penalties determined by the judges (**Section 6.9**).

The use and addition of covering material, adhesive tape, glue, screws or rivets, and components (or reinforcements) internal to the structure for repair are not considered project alterations.

The replacement of identical parts to the originals for any part of the aircraft will be allowed. Therefore, the team is allowed to bring a spare aircraft.

10.4 Testing at a Specific Location

10.4.1 Running Motors

In the competition, there will be a designated area for this purpose. More information about this area can be found in the document **Operational Procedures - SAE AeroDesign**.

R[10.4.1.1] The team must not run the motor outside the delimited area for this purpose.

NC[10.4.1.1] The team will be asked to stop, and if they persist, will be penalized according to **Appendix 7 Section 7.3**.

VV[10.4.1.1] Competition.

When teams run the motors, they must always keep safety in mind by keeping tangential directions to the propeller clear, i.e., without pointing towards anyone. Failure to comply with this requirement constitutes a risk situation and may result in warnings and/or penalties.

10.5 Scoring

The preliminary score announcement will be made at the awards ceremony on the last day of the competition. The final score will be published on the SAE BRASIL website and sent to the teams within ten (10) days after the competition. The overall score will be calculated as follows:

$$\text{Total Points} = \sum \left\{ \begin{array}{l} +\text{Design Competition Points} \\ +\text{Flight Competition Points} \\ +\text{Applicable Bonuses} \\ -\text{Penalties} \end{array} \right. \quad (10.1)$$

10.5.1 Design Competition

The Design Competition will be scored according to the following criteria:

- Report and Technical Drawings.
- Oral Presentation.

The score assigned to the design competition can be checked in **Section 11.1**.

10.5.2 Flight Competition

To be eligible to participate in the flight competition, the team must:

- Submit a valid video of a flight (**Section 6.22**)
- Deliver all applicable documentation (**Appendix 9**)

The sections corresponding to the scores applicable to each class in the flight competition are:

- Regular Class: see **Section 7.7**;
- Advanced Class: see **Section 8.10**;
- Micro Class: see **Section 9.7**.

In each of these sections, there are subsections for each type of score. Some of these subsections are classified according to the following classes (as detailed in the title of each one):

- **[per flight test battery]** - These are non-accumulative scores. This means that each test battery will have its own score. The score used in the final classification is from the best battery, i.e., the one that scores the most points. They may be bonuses.
- **[once in the competition]** - These are bonuses, factors, or other calculations made only once during the competition and will be added to the final score or used in calculations of other points throughout the competition.
- **[accumulative]** - These are bonuses awarded in each flight battery and that, when added together, compose the total bonus.

The total flight score will never be less than Zero, even if any penalties applied in the flight phase lead to negative scores.

10.5.3 Penalties

Some penalties provided for are presented in the tables of **Appendix 7**, however, depending on the case, other penalties may occur.

The total competition score will never be less than Zero, even if any penalties applied throughout the competition lead to negative scores.

11. Report and Presentation - All Classes

The SAE AeroDesign Competition is divided into two parts:

- Design Competition
- Flight Competition

The Flight Competition, detailed in **Chapter 10**, assesses the actual capability of the built aircraft.

In the Design Competition, the team will present its project justifying the decisions made and the calculations used for the aircraft design and the prediction of the maximum payload that can be carried during flights. This part of the competition precedes the Flight Competition.

11.1 Design Competition

The Design Competition is divided into two parts:

- Technical Project Reports, including:
 - Report for each discipline;
 - Plans and technical drawings;
 - Prediction of payload;
 - Other documents, as applicable;
- Oral Presentation

The maximum total score for the design competition will be **225 points for the Regular and Micro Classes** and **250 points for the Advanced Class**.

Of this total, **185 points (210 points for the Advanced Class)** will be allocated for the evaluation of the reports and plans. The score will be subdivided for the technical report of each subject as follows:

Report / Subject	Maximum Score
Conceptual and preliminary design and integration	30 points (20+10: report and drawings)
Aerodynamics	25 points
Performance	25 points
Stability and Control	25 points
Aeroelasticity and Loads	25 points
Structures and Structural Tests	30 points (20+10: report and drawings)
Electrical Design and Safety Assessment	25 points
Onboard Systems (glider)	25 points (Advanced Class only)

The content and quality of each report and drawing will be assessed within these scores. Creativity and innovation will also be evaluated consistently within each of these subjects.

For teams in the Advanced Class, the glider design developed must be demonstrated in the Report for each discipline and preferably immediately after the presentation of the main aircraft or 'mother ship'. This organization facilitates evaluation by the judges.

The Oral Presentation will be worth 40 points.

The minimum grades for the Project Report and Oral Presentation are zero. That is, if penalties applied to a certain team result in a negative score, it will be corrected to zero.

11.2 Project Originality

R[11.2.0.1] The Project Report, Plans, and Oral Presentation must be original and should not be similar to those of other teams or previous years.

NC[11.2.0.1] The score of the plagiarized document will be zeroed.

VV[11.2.0.1] Report evaluation.

11.3 Technical Project Reports

11.3.1 Submission of Reports

R[11.3.1.1] The team must submit through the website www.aeroct.com.br a technical report for each of the subjects presented in **Section 11.1**.

NC[11.3.1.1] Missing documents will receive a grade of zero.

VV[11.3.1.1] Document submission and report evaluation.

R[11.3.1.2] Each PDF file of the report according to requirement R[11.3.1.1] must contain a cover (showing the team identification and college), indexes, symbol lists, lists of inputs and outputs of the subject, bibliographic references, and other items applicable to a project report. Observe the report structure in **Appendix 8**.

NC[11.3.1.2] The report grade will be affected.

VV[11.3.1.2] Report evaluation.

R[11.3.1.3] The team must submit through the website www.aeroct.com.br the required technical drawings in **Section 11.4** and additional ones, in separate files.

NC[11.3.1.3] Missing documents will receive a grade of zero.

VV[11.3.1.3] Document submission and report evaluation.

If the team does not submit any of the mandatory documents from requirements R[11.3.1.1] and R[11.3.1.3], the team will be considered withdrawn and will not be eligible to participate in the flight competition.

R[11.3.1.4] The team must submit through the website www.aeroct.com.br the additional documents required for the Advanced and Micro Classes.

NC[11.3.1.4] Aircraft may not be authorized to fly in the competition.

VV[11.3.1.4] Document submission and report evaluation.

R[11.3.1.5] The team must fill out the required data for each category, as mentioned throughout this Regulation on the website www.aeroct.com.br.

NC[11.3.1.5] Aircraft may not be authorized to fly in the competition.

VV[11.3.1.5] Document submission and report evaluation.

The website used for document submission will contain more detailed information regarding the formats and files that must be submitted. Possibly, the website may have other functionalities. It is recommended that as soon as the website is available, teams access the submission section for each document to ensure which documents and information need to be submitted on each date (as per **Appendix 9**).

It is the responsibility of each team to access the website www.aeroct.com.br with adequate advance notice to perform tests and understand the website's operation. Delays in document submission will be penalized as per **Appendix 9**, regardless of whether such delays occurred due to the team's inexperience in using the website. Only in cases of force majeure (such as the server hosting the website undergoing maintenance exactly on the day of document submission), the Technical Committee may take actions not foreseen in the Rules to avoid affecting the teams.

Each judge responsible for evaluating the reports will assess only the report of the subject within their competence. Therefore, if the team includes mixed information from subjects, they will not be properly evaluated. Example 1: A judge who evaluates stability and control will only read the report of this subject. If there is stability and control information within another subject's report, it will not be evaluated by the stability and control judge. Example 2: The team includes the determination of forces on the servos in the electrical design discipline instead of loads and aeroelasticity. Thus, to guide teams on which reports should contain which information, pay attention to the table in **Appendix 3**. It is important to keep in mind that judges evaluate the overall content of each report and the team's design logic, meaning that **the table presented in Appendix 3 does not constitute a checklist to be used by judges in evaluation**.

Instructions regarding the aircraft construction process are not evaluated. The method of manufacturing the aircraft can be visually explained in the technical drawings.

11.3.2 List of Inputs and Outputs

R[11.3.2.1] At the beginning of the report for each subject, a list of inputs for the calculations of that subject must be presented.

NC[11.3.2.1] The report grade may be compromised.

VV[11.3.2.1] Report evaluation.

R[11.3.2.2] At the end of the report for each subject, a list of outputs for the calculations of other subjects must be presented.

NC[11.3.2.2] The report grade may be compromised.

VV[11.3.2.2] Report evaluation.

R[11.3.2.3] The list of inputs and outputs must be presented in the form of a list, table, or flowchart and can be presented as a figure.

NC[11.3.2.3] The report grade may be compromised.

VV[11.3.2.3] Report evaluation.

R[11.3.2.4] Inputs and outputs must contain values. Writing only the term name (e.g., $C_{L_{max}}$) is not sufficient; its value is necessary.

NC[11.3.2.4] The report grade may be compromised.

VV[11.3.2.4] Report evaluation.

This is necessary to facilitate the link between subjects. For example, a load presented as an output of the loads report will be an input for the structural calculations report. Another example, maximum lift coefficients are outputs of the aerodynamics report and inputs for the performance report. And so on for all subjects.

In general, the report for each subject must be self-contained, meaning that for the judge reading a particular subject, it should not be necessary to consult others to identify the data needed for evaluation.

11.3.3 Report Format and Limitations

The limitation in terms of report formatting will be given by the maximum number of words and file size (**5Mb**).

A specific Python software will be used to count the words contained in the complete file of the report for each subject, as described in **Appendix 8**. It is suggested to use an index page and a symbol list page to facilitate reading and interpretation by the judges. Lists of figures and tables are not necessary.

R[11.3.3.1] The report for each subject for each class must not exceed the number of words specified in **Tabela 11.1**.

NC[11.3.3.1] A penalty will be applied according to **Appendix 7, Section 7.4** for each report.

VV[11.3.3.1] Report evaluation.

Tabela 11.1: Maximum number of words per discipline.

Report / Subject	Regular	Advanced	Micro
Conceptual and preliminary design and integration	3300 words	3800 words	3300 words
Aerodynamics	2800 words	3300 words	2800 words
Performance	2800 words	3300 words	2800 words
Stability and Control	2800 words	3300 words	2800 words
Aeroelasticity and Loads	2800 words	3300 words	2800 words
Structures and Structural Tests	3000 words	3500 words	3000 words
Electrical Design and Safety Assessment	2700 words	3200 words	2700 words
Onboard Systems	-	3700 words	-

The word count software is capable of counting words contained in figures or in equation mode of the Microsoft Word software, but it does not consider them in the total count of valid words. Therefore, if the use of figures or equation mode is found to deliberately insert text into the report, the team will be penalized according to **Appendix 7 Section 7.4**. The Python script will be used by the Technical Committee to check such irregular practices.

If any team exploits any code flaw in bad faith, without notifying the Technical Committee of a possible bug in the software, or benefits from another irregular practice not mentioned here, they are also subject to penalties as severe as the previously mentioned cases. Arguments of ignorance of the rule or irregularity of the practice will not be accepted, and the decision of the Technical Committee regarding the penalty will be final and irrevocable.

The software used by the Technical Committee in word counting can be accessed at the following GitHub link:

<https://github.com/comissao-aerodesign/PyAeroCounter>

More information about the custom software implemented in Python, information regarding the report structure, formatting, and other requirements are detailed in **Appendix 8**.

R[11.3.3.2] The reports must not contain media resources with sound and/or moving images.

NC[11.3.3.2] The resources will not be considered, and the grade may be affected.

VV[11.3.3.2] Report evaluation.

There are no standard formatting requirements, but it is suggested to use double spacing between lines, typed on A4 paper using Times New Roman font size 12 (with Normal character spacing).

The Technical Committee provides a LaTeX template at the following GitHub link:

<https://github.com/comissao-aerodesign/AeroTeX>

The use of LaTeX is only suggested, offering an opportunity for teams to learn to use a widely used text writing tool in academic and technical environments. Additionally, platforms like Overleaf allow online collaborative work for writing texts (<https://www.overleaf.com/>), ideal for AeroDesign teams.

The provided template also contains tips for using LaTeX, inserting formatted tables and graphics. The versioned files on GitHub can be automatically imported by Overleaf:



Figura 11.1: Import template from GitHub into Overleaf.

The recommended margins are: 2.5 cm left, 1.25 cm top, 1.25 cm right, and 1.25 cm bottom. See the figure below for better understanding.

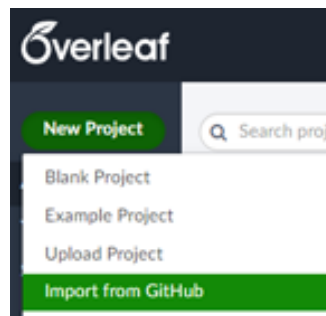

Figura 11.2: Recommended margins.

The header is not mandatory, but a space for the header must be reserved due to the current configuration of the word counting program. The software is programmed to disregard the header, and the implementation was based on the header's

position on the A4 sheet. Therefore, for the report to be compatible with the word counting software, the top margin and header must necessarily correspond to 2.7 cm in height.

R[11.3.3.3] The report must have a top margin (including header if it exists) totaling 2.7 cm for the correct functioning of the word counting software.

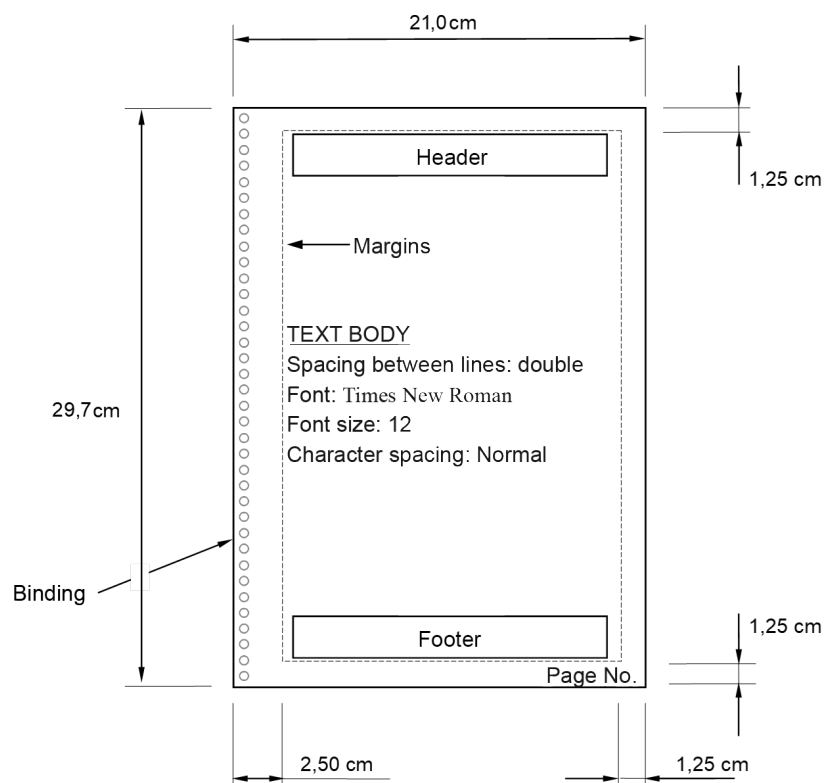
NC[11.3.3.3] Penalty of 5 points.

VV[11.3.3.3] Report evaluation by the software.

Two examples of cover pages for the report are shown in the following drawings. This pattern is not mandatory but only a recommendation. Special attention is requested to the positioning of the team name and number.

R[11.3.3.4] Reports must be written in Portuguese or English.

NC[11.3.3.4] A penalty will be applied as per **Appendix 7**.

VV[11.3.3.4] Report evaluation.



Figura 11.3: Examples

Finally, there has been a growing trend of excessive use of flowcharts and acronyms throughout the reports to increase the amount of documented technical information. However, the Technical Committee warns that quantity is not the same as quality, and the excessive adoption of flowcharts or acronyms hinders the evaluation of technical reports. For this reason, reports with such excessive practices will have their grades affected. It is part of

each team's technical challenge to synthesize didactically the relevant analyses and decisions made. In addition, the limitation on the size of the reports is mandatory to enable the evaluation process by volunteer judges. We count on the cooperation of the teams.

R[11.3.3.5] Reports must not adopt excessive flowcharts or acronyms that impact technical evaluation.

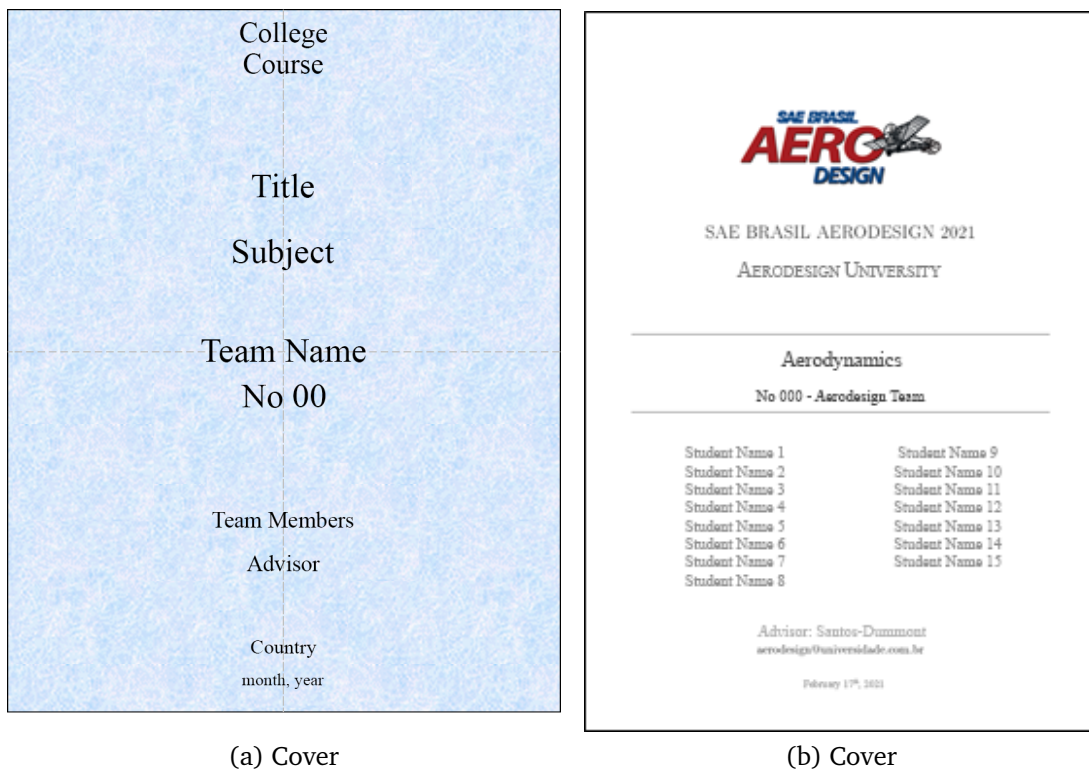
NC[11.3.3.5] The report grade may be compromised.

VV[11.3.3.5] Report evaluation.

11.3.4 Attachments and Appendices

The only attachments provided are those related to the documentation of the motor and battery of the propulsion system for the Advanced, Micro, and Regular classes (Sections 8.2, 9.3, 9.6.1, and 7.3.1, respectively). This attachment is a requirement for participation in these classes but is not scored as part of the report.

Attachments must be uploaded on the website www.aeroct.com.br in a separate PDF document from the report, so that the word count is not compromised (Subsection 11.3.3).

R[11.3.4.1] The team must not submit any attachments beyond those provided in this regulation.

NC[11.3.4.1] Attachments will be considered in the word count of the reports.

VV[11.3.4.1] Report evaluation.

11.4 Technical Drawings

The required technical drawings for each category are described in the table below.

Suggested order for technical drawings	Regular Class	Advanced Class	Micro Class
1	Three views of the aircraft	Three views of the aircraft	Three views of the aircraft
2	Fuselage layout, cargo compartment, landing gear and brakes, manufacturing and assembly details, etc.	Fuselage layout, cargo compartment, landing gear and brakes, manufacturing and assembly details, etc.	Fuselage layout, cargo compartment, landing gear and brakes, manufacturing and assembly details, etc.
3	Details of the complete cargo support, attachment to the fuselage, etc.	Details of the complete cargo support, attachment to the fuselage, etc.	Details of the complete cargo support, attachment to the fuselage, etc.
4	Wing (structure and details), attachment to the fuselage and control systems, manufacturing and assembly details, etc.	Wing (structure and details), attachment to the fuselage and control systems, manufacturing and assembly details, etc.	Wing (structure and details), attachment to the fuselage and control systems, manufacturing and assembly details, etc.
5	Horizontal and vertical tail, control systems, manufacturing and assembly details, etc.	Horizontal and vertical tail, control systems, manufacturing and assembly details, etc.	Horizontal and vertical tail, control systems, manufacturing and assembly details, etc.
6	Details of the installation of the electrical system (batteries, servos, voltmeter, motor, wattmeter, arm plug, etc.) and electrical diagram.	Details of the electrical system installation + electrical diagram and installation of onboard instrumentation, motor, arm plug, etc.	Installation details + electrical system diagram (batteries, BEC, motor, arm plug, etc.).
7	Free	Glider developed drawing (A3 or A2), see Subsection 11.4.4	Assembly and Disassembly Process + Aircraft in Box (A3 or A2)

R[11.4.0.1] The technical drawings in **bold** in the table above must be submitted containing at least what is described for the respective Class. Additional information may be added.

NC[11.4.0.1] A penalty will be applied as per **Appendix 7, Section 7.6.**

VV[11.4.0.1] Report evaluation.

The other technical drawings do not have mandatory content, but only suggested.

R[11.4.0.2] The technical drawings must all be made on A3 size paper (unless indicated otherwise).

NC[11.4.0.2] Technical drawing not accepted.

VV[11.4.0.2] Report evaluation.

R[11.4.0.3] All technical drawings must have a legend in the bottom right corner (ABNT standard) containing the college name, team name, and number.

NC[11.4.0.3] Technical drawing not accepted.

VV[11.4.0.3] Report evaluation.

R[11.4.0.4] The team must not submit more than 7 technical drawings.

NC[11.4.0.4] A penalty will be applied as per **Appendix 7, Section 7.6**.

VV[11.4.0.4] Report evaluation.

If the team submits more than one technical drawing within the same PDF file, the excess of drawings will still be considered for the purpose of applying penalties.

Technical drawings are usually evaluated based on the following criteria:

1. Clarity and Neatness. Drawings that are too “cluttered” or confusing are difficult to visualize and/or understand.
2. Detailing of aircraft components and choice of views;
3. Possibility to reproduce the aircraft from the drawings. Do the drawings contain all the necessary visual (and written) information for the correct construction of the aircraft (parts, dimensions, materials used, etc.)?
4. Use of technical standardization for representing the aircraft and its subsets (dimensions, cuts, views, details, among others).
5. General detailing of the aircraft. Cargo, cargo support, and their attachment to the fuselage. Basic structures and attachment of main components; installation of control surfaces, servos, and links, installation of the electrical system (servos, batteries, motor, etc.).

Special attention is requested for the structural details of the aircraft to be represented in the technical drawings. These should be represented in such a way that allows judges and specialists in the areas of Conceptual and Preliminary Design and Integration and Structures and Structural tests to fully visualize how the main structural elements are built, such as the spar section, wing-fuselage connection, tail cone attachment, among other pertinent items that are related to the type of aircraft.

Teams can create colorful technical drawings as long as the color scheme used does not affect the clarity or interpretation of the technical drawings. An excessively colorful technical drawing is not necessarily easier to understand than one made in black and white.

The following subsections address respectively the details of the mandatory and open technical drawings.

11.4.1 Three-View Aircraft Drawings (Technical Drawing 1)

R[11.4.1.1] Technical Drawing 1 must contain the drawing of three views in standard aeronautical format.

NC[11.4.1.1] A penalty will be applied as per **Appendix 7, Section 7.6**.

VV[11.4.1.1] Report evaluation.

The standard aeronautical format includes: top view of the plane on the upper left side of the sheet, with the nose down; below it, the front view of the plane with the side view to its right with the nose of the plane to the left of the sheet (see **Appendix 5**).

R[11.4.1.2] At the top of the side view of Technical Drawing 1, there must be a table with a summary of the aircraft data with AT LEAST the information requested in the examples in **Appendix 5**.

NC[11.4.1.2] Drawing grade affected.

VV[11.4.1.2] Report evaluation.

R[11.4.1.3] Units must always be in the metric system, as per the example table.

NC[11.4.1.3] Drawing grade affected.

VV[11.4.1.3] Report evaluation.

A perspective view of the aircraft can also be added to this view, above the side view, as long as it does not hinder the visualization of the three views as well as the data table.

R[11.4.1.4] Technical Drawing 1 for the Regular Class must necessarily show the length and maximum wingspan of the aircraft (B Wing and L in **Appendix 5**).

NC[11.4.1.4] A penalty will be applied as per **Appendix 7, Section 7.6**.

VV[11.4.1.4] Report evaluation.

11.4.2 Details of the Electrical System (Technical Drawing 6)

R[11.4.2.1] Technical Drawing 6 must contain the details of the electrical system.

NC[11.4.2.1] A penalty will be applied as per **Appendix 7, Section 7.6**.

VV[11.4.2.1] Report evaluation.

In this technical drawing, it is important to show not only the electrical diagram of the aircraft but also the installation and fasteners of the respective components of this system in the aircraft structure (technical drawings). It is interesting for the team to provide a detailed description of the characteristics of the servomotors used (working voltage, torque, etc.) in each position of the aircraft, of the battery(ies) adopted, indicate the position of the receiver and other components of the electrical system.

R[11.4.2.2] For the Advanced class, the drawing must also show the details of the data acquisition system.

NC[11.4.2.2] Technical Drawings grade affected.

VV[11.4.2.2] Report evaluation.

This technical drawing was adopted to increase the information necessary for a more complete evaluation by the Electrical Design and Safety Assessment subject.

11.4.3 Assembly and Disassembly Process + Aircraft in Box [Micro class only]

R[11.4.3.1] Technical Drawing 7 for the Micro Class must primarily contain a detailed assembly and disassembly process of the aircraft clearly demonstrating how the aircraft is disassembled and packaged in the box developed by the team, as well as the execution order. The assembly procedure drawing is mandatory, showing the aircraft in the box will be used to evaluate the packaging of the components. If necessary, this drawing can be made in a A2 sheet to be complete.

NC[11.4.3.1] A penalty will be applied as per **Appendix 7, Section 7.6**.

VV[11.4.3.1] Report evaluation.

The drawings must follow the recommendations described in **Sections 9.5 and 9.5.2** for the Micro Class (see example in **Appendix 6**).

R[11.4.3.2] Technical Drawing 7 for the Micro Class must contain the INTERNAL dimensions of the box and the listing of the subassemblies contained in the box must be present in this drawing, in the upper right corner, as shown in **Appendix 6**.

NC[11.4.3.2] Technical Drawings grade affected.

VV[11.4.3.2] Report evaluation.

11.4.4 Glider Technical Drawing [Advanced class only]

R[11.4.4.1] Technical Drawing 7 for the Advanced Class must contain the glider developed with all the basic components of the glider structure and their respective optimizations for each of the Missions. It is recommended that this drawing be in a A2 sheet in order to detail the entire glider and, where applicable, all its systems and installations.

NC[11.4.4.1] A penalty will be applied as per **Appendix 7, Section 7.6**.

VV[11.4.4.1] Report evaluation.

11.4.5 Open Technical Drawings

The team may choose which drawings, views, cuts, mechanisms, systems, etc., will be shown to complement the information provided in the other technical drawings.

It is recommended to use these technical drawings to show views and assembly details of parts of the aircraft, mechanisms, or other items that may not have been shown in the previous drawings.

11.5 Payload Capacity Estimate Graph - “Accuracy”

The payload capacity prediction graph is generated by the website www.aerocraft.com.br. The team does not need to create their own graph in a separate PDF file. The methodology for obtaining the graph will be judged in the Performance subject, in the project report.

The data will be linearized over a relevant range, and the graph representing the payload capacity prediction as a function of density altitude through a linear equation, using the coefficients a and b of a line $Y = a \times X + b$ (where X represents the Density Altitude in meters, and Y represents the payload in kg).

For more details on density altitude, refer to **Appendix 4**.

R[11.5.0.1] The coefficients a and b of the payload capacity prediction graph must be entered in the appropriate fields of the website www.aeroct.com.br.

NC[11.5.0.1] “Accuracy” score zeroed.

VV[11.5.0.1] Website www.aeroct.com.br.

In some cases, the predicted payload capacity may be limited by other factors, requiring the indication of the maximum loaded payload, generating a constant level on the graph.

R[11.5.0.2] If the team has a maximum payload value, it must be entered in the appropriate field of the website www.aeroct.com.br.

NC[11.5.0.2] The graph will not have the maximum level.

VV[11.5.0.2] Website www.aeroct.com.br.

An example of the graph generated by the Technical Commission’s website is shown below:



Figura 11.4: Example of Payload Capacity Estimate Graph.

11.6 Aircraft Data Template

Together with the submission of the technical reports, documentation of the engine(s), battery(ies), and technical drawings, additional information about the aircraft is required for the submission to be complete on the website www.aeroct.com.br. They are:

- Motor used.
- Propeller used (brand, pitch, and diameter).
- Maximum height of the aircraft (H) [m].
- Maximum wingspan of the aircraft (B) [m].
- Empty weight of the aircraft [kg].
- Wing area (if there is more than one wing, enter the value of the sum of the areas of all wings) [m^2].
- Wing aspect ratio (if there is more than one wing, enter the value of the average aspect ratio of all wings).
- Maximum CL of the aircraft.
- MTOW of the aircraft [kg].
- Type of aircraft (monoplane, biplane, triplane, canard, tandem wings, flying wing, etc.).

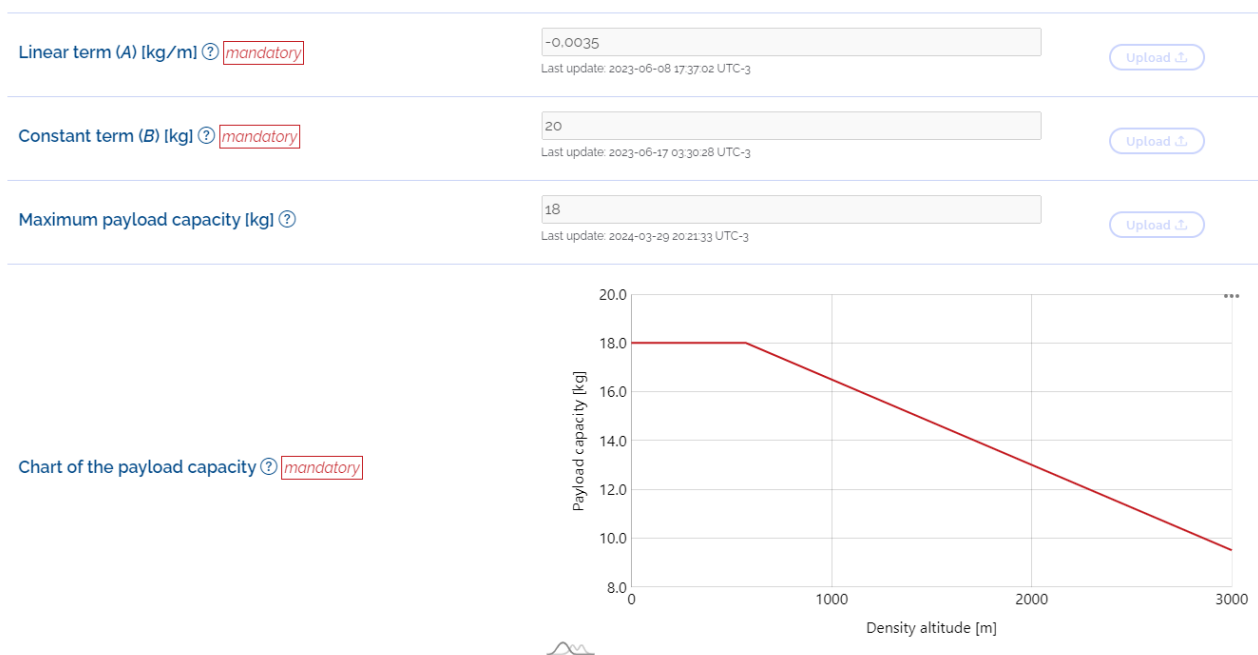
Propeller used ? mandatory	teste2 A ç <small>Last update: 2023-08-15 22:26:21 UTC-3</small>	<input type="button" value="Upload ↴"/>
Wing area [m^2] ? mandatory	1.000512312 <small>Last update: 2023-06-08 12:36:36 UTC-3</small>	<input type="button" value="Upload ↴"/>
Aircraft type ? mandatory	Monoplano convencional <small>Last update: 2023-08-30 22:08:52 UTC-3</small>	<input type="button" value="Upload ↴"/>

Figura 11.5: Fields for entering aircraft data on the website www.aerocraft.com.br

The delivery of the mentioned data above is mandatory.

R[11.6.0.1] The engine, propeller, maximum height, maximum wingspan, empty weight, wing area, aspect ratio, maximum CL, MTOW, and type of aircraft data must be entered in the appropriate fields of the website www.aerocraft.com.br.

NC[11.6.0.1] Team prevented from making the final submission of project documents.

VV[11.6.0.1] Website www.aerocraft.com.br.

11.7 Late Submission Penalty

R[11.7.0.1] The sets of reports, technical drawings, and payload capacity estimate graph as well as any other applicable documents, must be submitted through the website www.aerocraft.com.br to the Technical Commission by the deadline indicated in **Appendix 9**.

NC[11.7.0.1] Documents penalized as per **Appendix 7 Section 7.5**. After the maximum date for submission with penalties according to **Appendix 9**, the submission of the report will no longer be accepted.

VV[11.7.0.1] Report evaluation.

11.8 Errata

ATTENTION: ERRATA TO THE REPORTS, DRAWINGS, AND DATA POSTED ON THE WEBSITE www.aeroct.com.br WILL NOT BE ACCEPTED. Any document received by the Technical Commission as Errata or Correction of any kind will be disregarded. Parts of the report submitted separately will also be disregarded. Attention: do not confuse “Project Change” presented in **Section 6.9** with errata of project information.

11.9 Information Discrepancies

A series of significant information for team score calculations are provided in various documents such as technical drawings, reports, and the website www.aeroct.com.br.

In case of information discrepancies, the information provided on the website www.aeroct.com.br shall prevail. If the information provided on the website happens to be incorrect, errata will not be accepted, as per **Section 11.8**. However, only for values entered on the website, exceptional cases may be accepted, where a typing error is identified (example: empty weight entered in grams instead of kg. This is obviously a typing error, as 3500.0 g is a reasonable value for an empty weight, while 3500.0 kg is an absurd value. Obviously, the intention was to enter 3.5000 kg). Nevertheless, for cases of typing errors on the website www.aeroct.com.br, a penalty will be applied as per **Appendix 7 Section 7.5**.

11.10 Oral Presentation

11.10.1 Online Phase

With the aim of democratizing team access to the Project Competition phase, facilitating future access to presentations of all teams, avoiding gatherings in closed spaces, and continuing to allow knowledge exchange between the Technical Committee and Competitors, oral presentations, as in recent years, will be conducted **online using the Zoom software on a date to be disclosed in a future revision of the regulations. The presentation schedule will be announced on the date provided in Appendix 9.** The presentations will be evaluated, recorded, and freely accessible to participating teams and the general public through links to broadcasts on Youtube (to be disclosed). These links will be available on the Technical Committee’s Instagram as well as on the website www.aeroct.com.br. Entry passwords will be available on the website www.aeroct.com.br and will be sent to the registered email on the website.

Access links to Zoom will also be made available on the Technical Committee Aero-Design Instagram (@comissao.aerodesign).

R[11.10.1.1] Teams must confirm attendance at the online presentation according to the schedule to be disclosed in a future revision of the regulations

NC[11.10.1.1] Team will not be able to make the oral presentation and will have its presentation score zeroed.

VV[11.10.1.1] List of confirmed teams via official WhatsApp channel, as described in **Section 3**, until the date to be disclosed in a future revision of the regulations

The presentation template is open.

Also, the use of the Zoom tool for live streaming on Youtube creates a blind spot and a watermark as shown in the figure below.



Figura 11.6: Example of an oral presentation on Zoom.

For referees and evaluators who will be in the Zoom room, these spaces will be visible according to the original presentation file, without the presenter's video overlay and without the Zoom watermark. Therefore, **the use of these spaces in the presentation is optional, without penalty in the evaluation.**

The order of presentations will be disclosed in a future revision of the Rules.

It is recommended that **5 minutes before the scheduled time** the team members start their entry in the provided link for the start of the presentation, as there will be a "Waiting Room" where members must wait until they are admitted to the Main Presentation Room. **This admission will occur within 5 minutes after the scheduled time**, and no entry will be allowed after this period, requiring the start of the presentation (start of the timer) with only the members already in the room.

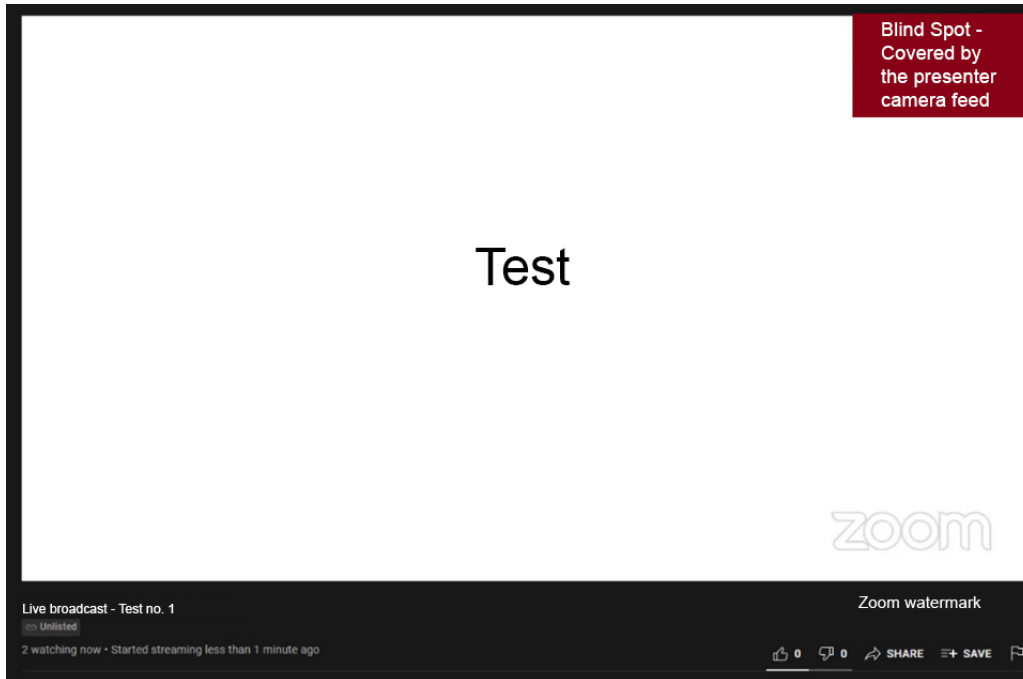
R[11.10.1.2] Team members must enter the "Waiting Room" within 5 minutes after the scheduled time.

NC[11.10.1.2] Inability to enter the Main Presentation Room.

VV[11.10.1.2] Room Supervisor, 5 minutes after the scheduled time.

If on the day of the presentation the presenter of any team has connection problems, the presentation will be rescheduled for the end of the day. It is recommended to change the presenter to avoid the problem happening again. Any situations not foreseen in this regulation will be discussed on a case-by-case basis by the members of the Technical Committee.

To facilitate the management of competitor entries and exits from Virtual Presentation Rooms, team members must follow the template below when creating their name before

entering the “Waiting Room”. Entry into the Main Room will not be authorized for members whose names are not in the template below.

Template: [3-digit Team Number] [A]* Full name according to the SAE registration.

* [A] is only mandatory if the member is the presenter. Examples: [006] [A] Diego Lima, [210] Diego Moraes

R[11.10.1.3] Team members must follow the template to create their name.

NC[11.10.1.3] Member with a name diverging from the template may not be authorized to enter the Main Presentation Room.

VV[11.10.1.3] Authorization Window for Entry into the Main Room.

Participants will enter the Main Room without access to the microphone and video. Only the Presenter(s) will be authorized to share screen, open microphone, and open video. The Room Supervisor will give instructions and time the presentation. When there is 1 minute left in the presentation, the Supervisor will alert the team about the remaining time using a reaction like a clock or raised hand in the “Reactions” button of Zoom. The reaction appears in the upper left corner of the participants’ screen and disappears after 10 seconds.

After 15 minutes from the start of the presentation, a proportional penalty per minute will be added up to a maximum of 30 minutes from the start of the timer. Upon reaching 30 minutes, the presentation will be interrupted, and there will be no time left for questions.

R[11.10.1.4] The maximum duration of the presentation without penalty shall be 15 minutes.

NC[11.10.1.4] Penalization according to the Table in **Appendix 7**.

VV[11.10.1.4] At the end of the Oral Presentation.

R[11.10.1.5] The maximum duration of the presentation shall be 30 minutes.

NC[11.10.1.5] Interruption of the presentation, and no questions from the evaluators.

VV[11.10.1.5] At the end of the Presentation or upon reaching 30 minutes of presentation, whichever comes first.

At the end of the presentation, time will be allocated for questions from the evaluators. Responses to these questions must be initiated by the presenter (the only team member with the open microphone). If the presenter wants another member to answer or feels the need to involve another member to complement their answer, they must mention the competitor by name. The mentioned competitor must request permission to change their microphone through the “Reactions” button (with any reaction) to facilitate identification by the committee and expedite microphone release. We ask that only one competitor at a time have an “active reaction”. If the Supervisor finds the person before they activate the reaction, he/she will authorize microphone release even without the reaction. It is also important: if the person mutes the microphone, they will not be able to unmute it until the Room Supervisor allows it again, so we ask for attention to avoid communication and time problems.

11.10.2 On location Phase

In addition to the oral presentations made by all teams, all teams are called upon to exhibit their planes in the competition hall on the Thursday of the flight competition week, as per **Appendix 9**.

It is already defined that the event will feature team accreditation, an opening ceremony with sponsors.

R[11.10.2.1] Teams called by the Technical Committee must attend the opening/team reception ceremony.

NC[11.10.2.1] Application of penalties to be specified.

VV[11.10.2.1] Technical Committee analysis of the justification for absence in the presentation.

The complete event schedule for the first day of the competition will be made available in due course through the Technical Committee's social media and email to registered teams.

11.11 Feedbacks on the Project from the Judges

The projects (reports, technical drawings, and graph) will not be corrected but rather read, verified, discussed among the judges, and scored.

The judges' scores will be final, and no revisions will be allowed.

Feedbacks regarding each project can be provided through various means, as exemplified below:

- Questions during the oral presentation;
- Analysis by the team of the aircraft's performance in flight tests and competitions;
- Comparative analysis of other teams' aircraft and their performance during the competition;
- Conversations with other teams;
- Conversations with judges during the competition. Technical Committee members are also Competition Judges and **when possible** during the competition, they may talk to you.
- After the competition, through disclosure of notes made by judges during evaluation of reports and blueprints.
- Feedback written by judges on the website www.aeroct.com.br during the report evaluation process.

Appendix 1. Example of Load and Load Support



Figura 1.1: Example of load support. The dimensions shown are for illustrative purposes only.

Appendix 2. Primary and Non-primary Components

PRIMARY COMPONENTS	NON-PRIMARY COMPONENTS
Spars	Wing tip devices and their covering
Ribs	Fairings
Panels of lifting surfaces	Fuselage covering
Lifting surfaces covering	Tail cone covering
Guying	DAS electrical components
Fuselage structures	
Tail cone structures	
Landing gear and landing gear shaft	
Fastenings	
Studs	
Stays	
Flight commands	
Electronic components of control systems and propulsion systems	
Horns, links and arms	
Motors	

Appendix 3. Distribution of Subjects in the Reports

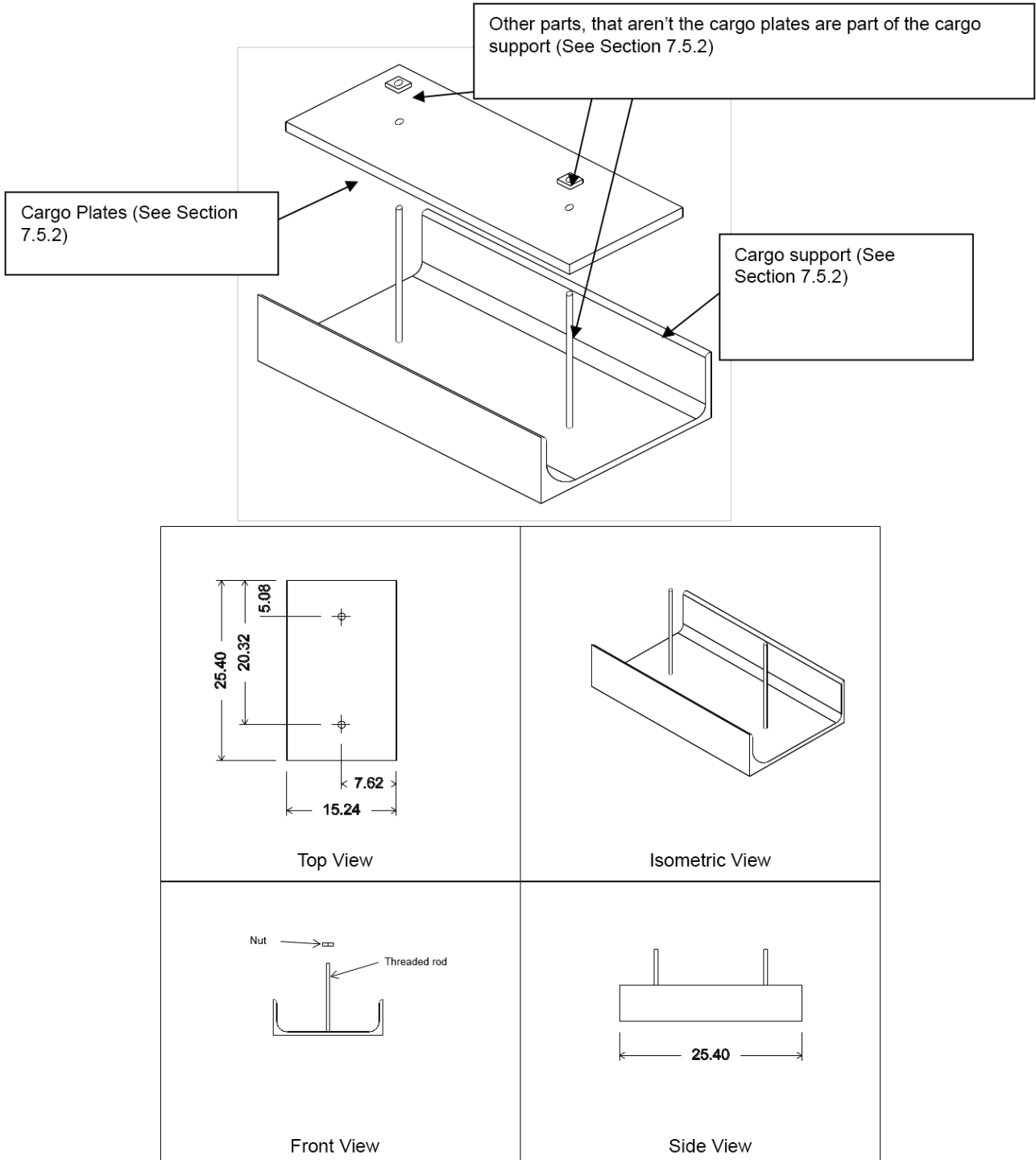
Subject/ Report	Report Content
<p>Conceptual and preliminary design and integration Report</p>	<ul style="list-style-type: none"> • Requirements analysis and management; • Multidisciplinary analyses and justifications for obtaining the aircraft concept and initial sizing (Conceptual Design); • Multidisciplinary analyses of the design solutions defined to prove the aircraft's feasibility (Preliminary Design); • Description of MDO modeling; • Description of innovative and different design solutions compared to previous years or other teams; • Brief presentation of tests and methodologies from other disciplines used to define the solutions adopted in their respective stages of the project; • Description of the use of artificial intelligence in the project (example: chatGPT); • Brief description of construction methods and processes.
<p>Aerodynamics Report</p>	<ul style="list-style-type: none"> • General aerodynamics evaluations; • Two-dimensional aerodynamic evaluations; • Three-dimensional aerodynamic evaluations; • Estimates and evaluations of downwash; • Requirements for aerodynamic design; • Profile selection and/or design; • Wing planform design; • Aerodynamic design of empennages and fuselage; • Determination of aerodynamic coefficients; • Design decisions that led to the team's choices in the field of aerodynamics.

Subject/ Report	Report Content
Performance Report	<ul style="list-style-type: none"> • Performance analyses related to the aircraft’s mission; • Forecast of payload or presentation of other results related to the aircraft’s mission, as per category; • Design decisions that led to the team’s choices in the performance field.
Stability and Control Report	<ul style="list-style-type: none"> • Criteria and requirements adopted by the team to govern stability and control sizing; • Use of stability and control analyses to collaborate with aircraft performance and safety; • Sizing of controls and empennage (size and deflections); • Description of methods and aerodynamic model used (semi-empirical methods, potentials, CFD, wind tunnel); • Lateral-directional stability and control analyses (stability and trim capability); • Longitudinal stability and control analyses (stability and trim capability); • Longitudinal and lateral directional control analyses (pitch at takeoff, load factor, ground directional control, roll rate); • Analysis of the aircraft’s dynamic stability (modes, poles, time response); • Theoretical knowledge over the analyses made; • Maneuvers and trims in flight tests conducted to corroborate the theoretical stability and control analyses; • In flight data acquisition and processing; • Use of flight simulator if applicable.

Subject/ Report	Report Content
Aeroelasticity and Loads Report	<ul style="list-style-type: none"> • Determination of static loads on the ground (e.g., taxi, takeoff, landing); • Definition of the Flight Envelope (V-n diagram); • Aerodynamic model used for load calculation; • Determination of aerodynamic, dynamic, and inertial loads for different flight conditions (maneuver, gust, level flight, etc.); • Determination of loads on controls (moments on control surfaces and servo actuators); • Static and dynamic aeroelastic stability evaluations and definition of the operational envelope; • Definition of the models and methodologies used for aeroelastic analyses; • Tests conducted to corroborate the theoretical loads and aeroelasticity analyses; • Design decisions made by the team for load optimization/reduction.
Structures and Structural Tests Report	<ul style="list-style-type: none"> • Presentation of structural strength analyses; • Evaluation of the strength of primary structure junctions; • Finite Element Analyses; • Safety margin evaluations; • Structure deflection assessments; • Presentation of material tests; • Presentation of structural tests; • Design decisions made by the team for structure optimization and reduction of empty weight.

Subject/ Report	Report Content
<p>Electrical Design and Safety Assessment Report</p>	<ul style="list-style-type: none"> • System architecture design; • Determination of loads, currents, demands, etc., including any force transfers; • Design and selection of electrical system components (batteries, servomotors, etc.) based on design data; • Wiring and connector selection; • Technical diagram of the designed systems; • Design decisions made by the team for a safe and efficient electrical system design; • Failure mode analysis; • Risk identification and mitigation; • Use of one or more risk assessment tools; • Elicitation of safety requirements; • Determination of the failure rate of the designed aircraft (by parts and complete) along with the judgment of whether the rate is suitable for the application.
<p>Onboard Systems and Glider Performance Report</p>	<ul style="list-style-type: none"> • Systems' architecture design; • Mission fulfillment planning; • Design and selection of electronic system components (batteries, sensors, microprocessors, cameras, etc.); • Sizing of wiring and safety measures associated with the electronic system; • Techniques and methodologies used for the design of any printed circuit boards and software development; • Detailing of any communication protocols between systems; • Glider mission tests.

Appendix 4. Density Altitude Calculations

The Technical Committee will provide teams with density altitude throughout the competition.

Density altitude is the ISA altitude that results in the same air density as the local atmosphere. Humidity is not considered in the equation used by the Technical Committee.

The data source will be a commercial weather station that provides pressure and temperature data. The equation below shows the density altitude calculation used for disclosure to the teams and considerations for Payload Accuracy scores.

$$Density\ Altitude = H_{\rho} = \frac{T_0}{0.0065} \left[1 - \left(\frac{\frac{P_{local}}{P_0}}{\frac{T_{local}}{T_0}} \right)^{0.234959} \right] \quad (4.1)$$

Where *Density Altitude* (H_{ρ}) is the density altitude used in accuracy calculations (in meters), T_{local} is the local temperature (in Kelvin), T_0 is the sea level temperature of the ISA standard atmosphere (288.15 K), P_{local} is the local pressure in *hPa* (hectopascal), and P_0 is the sea level pressure of the ISA standard atmosphere (1013.25 *hPa*).

Appendix 5. Three-View Drawing



Figura 5.1: Example of a Three-View Drawing. Use dimensions in the International System.

Appendix 6. Disassembled Aircraft in Box Layout (Micro Class Only)

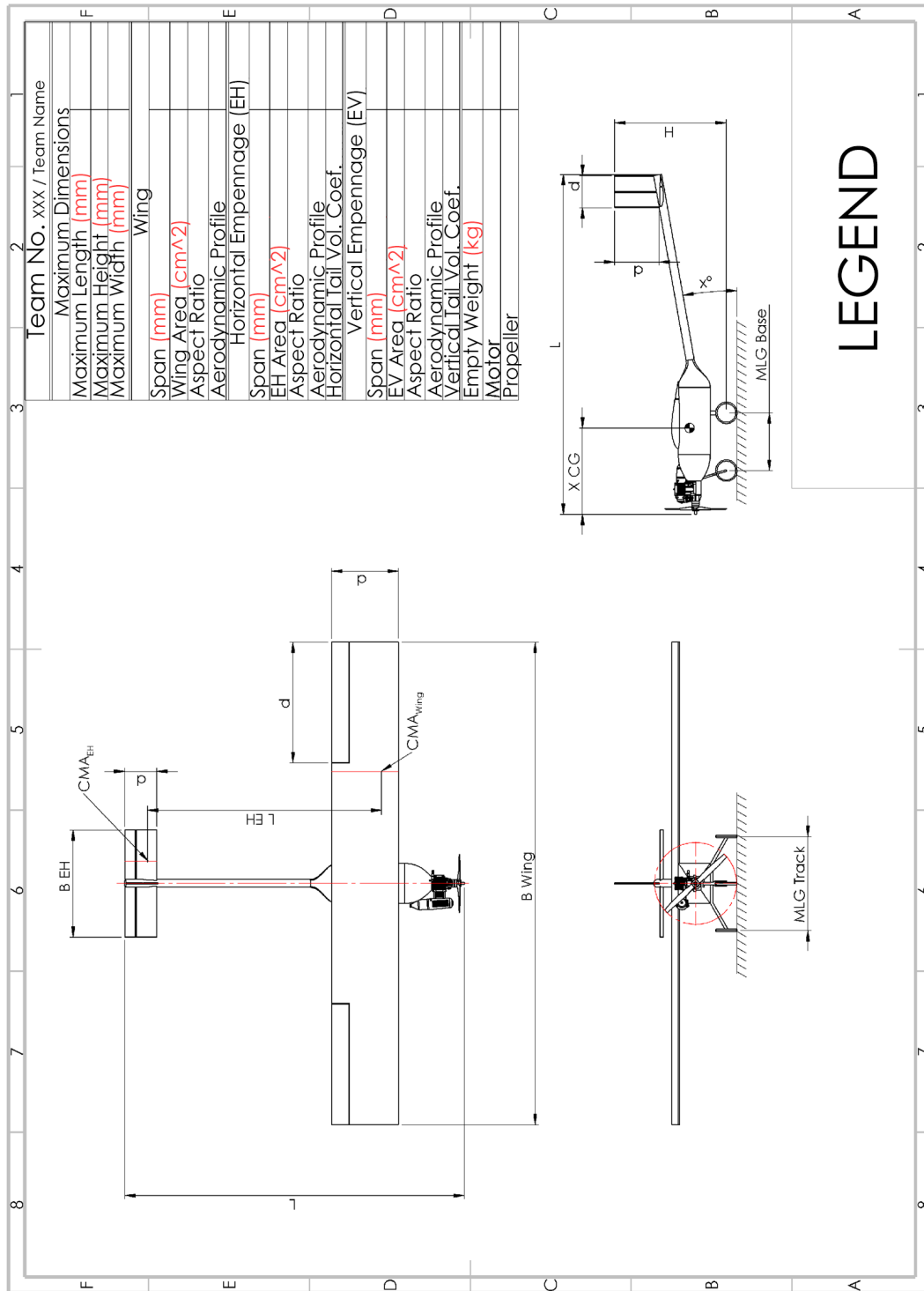

Figura 6.1: Example of disassembled aircraft in box layout. See Subsection 11.4.3 and Section 9.5.

Appendix 7. Penalties

Penalties are divided by subject:

7.1 Oral Presentation

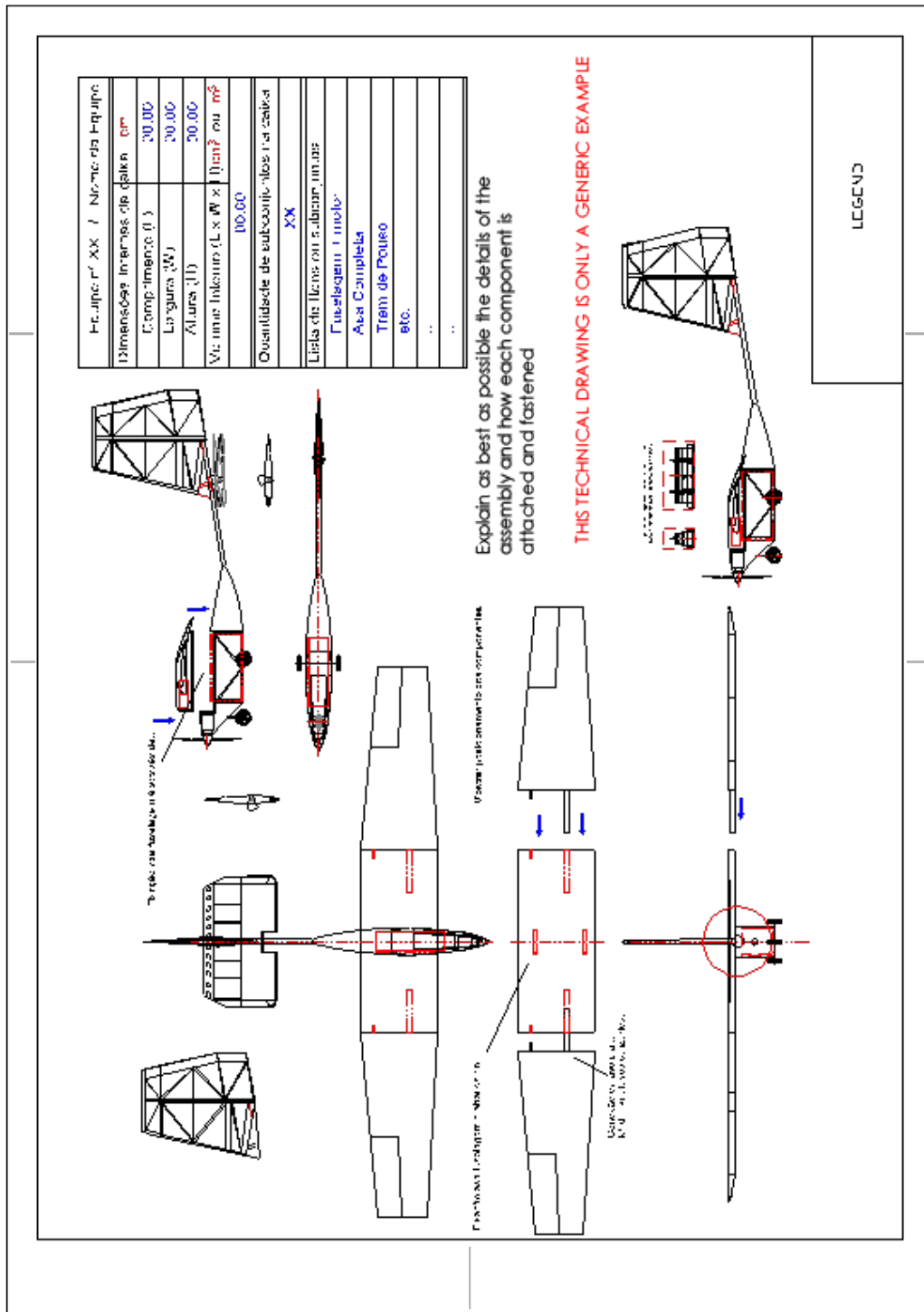
Description	Penalty
Delay in oral presentation	2 points/minute

7.2 Aircraft Non-Conformity

Description	Penalty
Replacement of parts different from the project without notification	up to 10 points
Any modification or removal of parts from the original servo actuators	up to 20 points
Repair of primary parts without proper notification - Regular Class	up to 20 points
Repair of primary parts - Advanced Class	up to 50 points
Aircraft with dimensions outside those specified in Section 7.2.	Penalty according to Section 7.2
Validate a flight of regular class with the aircraft exceeding the dimensional limits of requirement R[7.2.0.1] or micro class with the box exceeding the dimensional limits of requirement R[9.5.2.1] .	Cumulative 20 points
Use of unauthorized payload (unregulated or modified payload)	Flight invalidation or disqualification

7.3 Operational Items

Description	Penalty
Project alteration or disagreement with the project	Defined case by case
Performing the first flight in the competition	Not allowed
Disrespecting the delimited airspace	Subject to disqualification
Unfounded protests	up to 25 points
Deliberately violating safety rules	Disqualification
Unsportsmanlike conduct and/or deliberate rule infractions (proven misconduct).	Disqualification
Unforeseen safety violations	As per the case
Failure to submit the pilot registration form available at www.aerocb.com.br	Prevents the pilot from flying
Disrespect/disobedience towards judges and officials.	Minimum of 10 points up to disqualification.
Access to operational areas without the presence of identification (bracelet or badge)	Up to 10 points
Improper use of identification (bracelet and badge). This identification is personal and non-transferable (Section 4.6).	Up to 10 points
Excess power in electric motor of Regular Class (R[7.3.1.1])	1 point per exceeding Watt
Regular Class team turns off the Wattmeter before peak power reading by the inspector or it is not possible to read the wattmeter on the aircraft (R[7.3.1.5])	100 points on the battery
Validating flight with lateral escape (Subsection 10.1.8)	20 points on the battery
Regular Class - Validating flight with aircraft laterally displaced in climb after takeoff in relation to the obstacle, according to R[7.8.0.4]	20 points on the battery
Regular Class - Breaking the obstacle tape on approach for landing.	20 points on the battery
Advanced Class - Validating flight with aircraft laterally displaced in climb after takeoff in relation to the obstacle, according to R[8.11.0.4]	20 points on the battery
Advanced Class - Breaking the obstacle tape on approach for landing.	20 points on the battery

Description	Penalty
Non-Primary Component Breakage (Subsection 10.1.10)	20 points per component on the battery
Wheel breakage, but the aircraft rolls normally (R[10.1.10.5])	20 points on the battery
Wheel breakage, but the aircraft DOES NOT roll normally (R[10.1.10.5])	30 points on the battery
Team performs any repair after a standard flight (Subsection 10.1.9) and before being released to return to their bench.	From flight invalidation to team disqualification

7.4 Report - Formatting

Description	Penalty
Excessive number of words (R[11.3.3.1])	0.008 points/word
Use of figures or irregular use of the equation mode of <i>Microsoft Word</i> software to insert text into the report in sentences or short texts. (Subsection 11.3.3)	Estimate of words introduced with proprietary software and have them counted as excess words
Deliberate use of figures or equation mode of <i>Microsoft Word</i> software to insert text into the report in large parts of the text, such as pages or whole sections, tables with explanatory texts, and the like	5 points per figure/text section
Lack of technical specifications and modifications of engines and batteries appendices - Advanced and Micro classes	10 points per appendix
Report written in a language different from those authorized in Subsection 11.3.3	10 points

7.5 Report and Other Documents - Submission

Description	Penalty
Late submission of the complete report through the website. (Complete package, with reports of all technologies, technical drawings, and other documents). Maximum date for submission without penalty: Appendix 9 . Maximum date for receipt (acceptance) of the Report: Appendix 9 .	5 points per calendar day (fractionated by time)
Delay in sending the complete aircraft flight video as per Section 6.22	0.5 points per day of delay
Failure to present the complete aircraft flight video as per Section 6.22 by the deadline with penalty presented in Appendix 9 .	Prohibition of flight in the Competition environment
Lack of information on the website www.aerocb.com.br , such that such information cannot be recovered through other sources, such as technical drawings.	Loss of bonus rights or maximum penalty associated with missing information
Correction of relevant values that are incorrect on the website www.aerocb.com.br due to typing error.	Penalty of up to 50% of the bonus or value associated with the number that was typed incorrectly.

7.6 Technical Drawings - Formatting

Description	Penalty
Lack of the mandatory “3 views” technical drawing (Technical drawing 1 - Section 11.4)	15 points
Lack of other mandatory technical drawings according to the category (Section 11.4)	10 points per technical drawing
Lack of dimensional information on the technical drawings of the Subsection 11.4.1 and Subsection 11.4.3 sections	Up to 10 points per technical drawing. Depending on the missing information
Excess of technical drawings. Beyond the maximum presented in the table of Section 11.4	10 points per excess technical drawing

If necessary, penalties not listed above will be determined on a case-by-case basis. The decision on these penalties will be the sole responsibility of the Technical Committee members (yellow shirts). Only they can assign penalties not defined in the rules.

Appendix 8. Report Template for Each Subject (PDF Document)

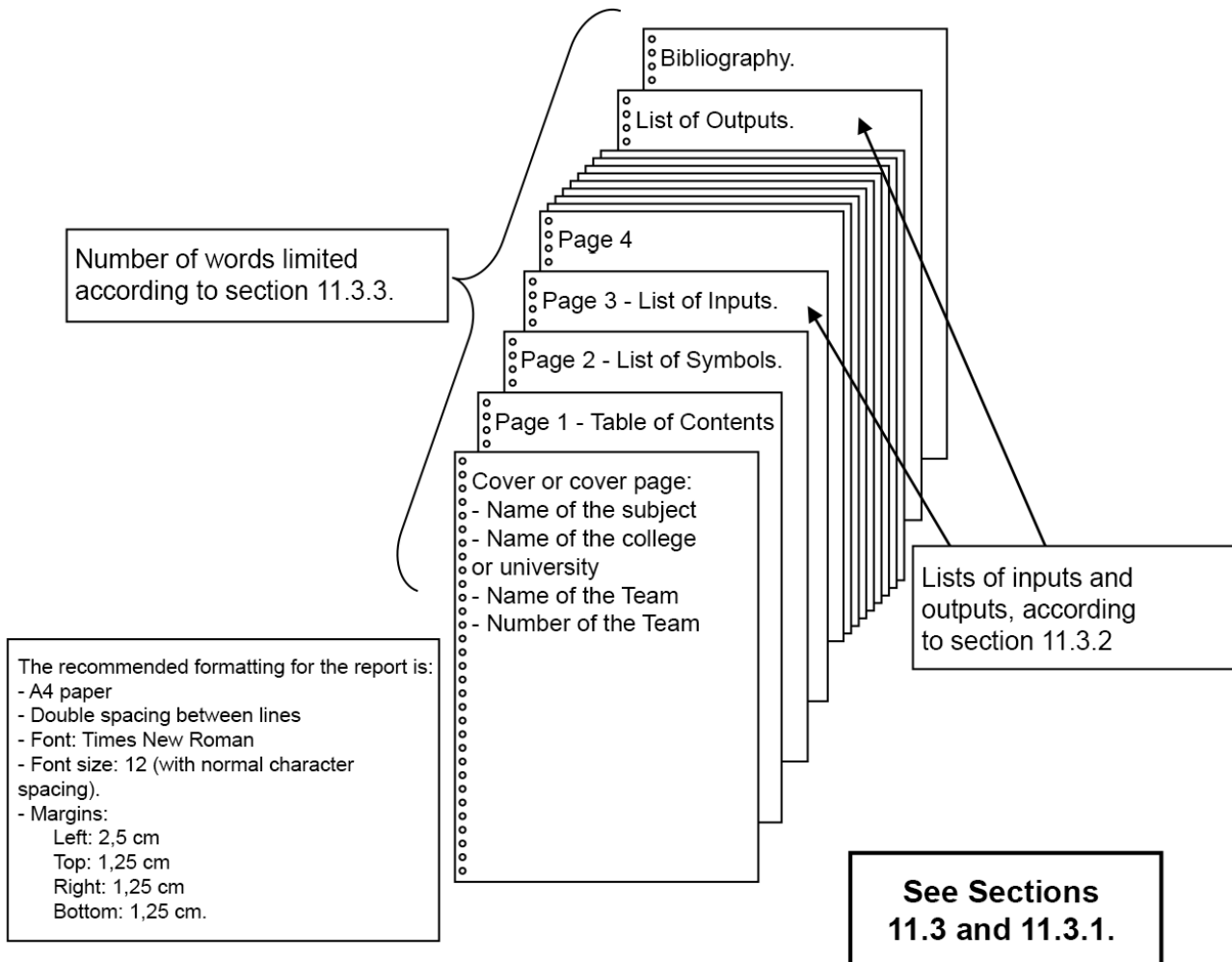

The official software for word counting in the report will be a custom software developed by the Technical Committee in Python and available at the following link:

<https://github.com/comissao-aerodesign/PyAeroCounter>

One of the advantages of in-house development is the clarity of the criteria for what is counted as a word and what is not, as well as certain peculiarities regarding the formatting of an AeroDesign technical report. With extensive use of the tool, improvements can be identified, so we encourage all teams to submit difficulties or suggestions on our website:

<http://www.aeroct.com.br>

Only the strings (text fragments) that make up the technical content and do not contain numeric characters or symbols in their composition will be counted as valid words. An installation tutorial and usage example are available on the GitHub page. Always stay

tuned for possible updates that will be informed through the Technical Committee’s Facebook and Instagram pages.

The code ignores the cover, as well as all pages treated as special that have their identification in the header. The pages considered special are:

1. List of Inputs
2. List of Outputs
3. Table of Contents
4. Bibliographic References
5. List of Symbols and Abbreviations

For the code to identify that page as a special page, its name must appear in the header, as in the example below:

Table of Contents	
<hr/>	
Table of Contents	
List of Inputs	2
1 Introduction	4
1.1 Objective	5
1.2 Scope	5
2 Content	6
3 Conclusion	8
List of Outputs	10
Bibliography	12

In Microsoft Word, this can be done manually. In LaTeX, the Technical Committee provides an automated template with this functionality.

Another important piece of information is that the *PyAeroCounter* tool does not count words present in the header and footer as valid words, i.e., the use of header and footer does not affect the final word count, and space for the header must be reserved. The header and top margin together must correspond to 2.7 cm.

Thus, given that the new word counting tool is able to identify special pages and the word counting criteria are clear, no more image insertions will be accepted to insert text, tables, or entire pages in the report. Images should only be used for graphics, illustrations, photographs, etc. This way, the formatting and quality of the reports will be preserved.

In addition to counting valid words, the *PyAeroCounter* software also measures other parameters of the report for which we have SUGGESTED limits displayed in the table below. Reports that exceed these limits will be manually checked by the Technical Committee to identify possible excesses or irregular practices. All reports, even within these parameters, are subject to this type of analysis. The reference values for the suggested limits were the result of an analysis of the 2020 reports that respected all the restrictions required by the Technical Committee.

Reports	Suggested Limit (PyAeroCounter Parameters)				Total
	Non-Words	Words in Figures	Non-Words in Figures	Words in Math Mode (Microsoft Word)	
Stability and Control	600	1600	1200	40	5740
Structures and Structural Tests	600	1800	1400	10	6810
Aerodynamics	900	1200	3800	60	8760
Aeroelasticity and Loads	1200	1600	1200	150	6550
Performance	700	1200	900	20	5420
Conceptual and preliminary design and integration	400	1700	1100	10	6510
Electrical Design and Safety Assessment	700	700	500	10	4610

A text file is generated for each of these parameters by the *PyAeroCounter* tool so that it is clear what is being counted in each category of the report being analyzed. Based on this practice, the Technical Committee seeks to be clear in the instructions for limits and formatting of the report as well as to be transparent about what will be checked to identify possible irregular practices.

We reinforce our encouragement for the use of the LaTeX template provided by the Technical Committee at the following GitHub link:

<https://github.com/comissao-aerodesign/AeroTeX>

Appendix 9. Important Dates and Documents

Document	When to Submit	Where to Submit
Registration	According to information in the document SAE BRASIL AeroDesign Registration Rules 2024	N/A
Project Report (Section 11.3) Mandatory technical drawings (Section 11.4) Additional open technical drawings (Section 11.4) Documents required in Sections 7.3.1, 8.2, 8.5.1, 9.3, and 9.6.1 (when applicable).	Maximum submission date without penalty: August 4th, 2024 . Maximum submission date with penalty: August 18th, 2024	www.aeroct.com.br
Propeller design technical report ¹ (Section 6.17), when applicable.	August 4 th , 2024	www.aeroct.com.br
Announcement of the Oral Presentation Schedule	September 14 th , 2024	Official Channels, see Chapter 3
Communication about project changes. Project changes communicated by this date are subject to less severe penalties compared to those communicated or identified after this deadline.	Until September 29 th , 2024	www.aeroct.com.br
Enrollment certificate for the second semester of 2024, and explicit participation agreement.	Until September 29 th , 2024	www.aeroct.com.br
Single-engine flight report for Advanced Class (Section 8.6)	Until September 29 th , 2024	www.aeroct.com.br
Pilot registration or Notice if SAE pilot will be needed ²	Until September 29 th , 2024	www.aeroct.com.br

Document	When to Submit	Where to Submit
Video of a flight for Micro, Regular, and Advanced Classes (Section 6.22)	Maximum submission date without penalty: September 29th, 2024. Maximum submission date with penalty: until the day before the start of the flight competition (to be confirmed³)	www.aeroct.com.br
Micro Class assembly and disassembly video (Subsection 9.7.7)	Maximum submission date October 19th, 2024	www.aeroct.com.br
Preliminary list of approved aircraft for competition flight (Section 6.22)	October 6 th , 2024	Official Channels, see Chapter 3
Oral presentations	October 19 th , 2024	Online (Zoom)
Team Reception	October 30 th , 2024 ³	MAB
Opening event, aircraft exhibition, and accreditation	October 31 st , 2024 ³	ITA
Flight Competition	November 1 st , 2 nd , 3 rd , 2024 ³	DCTA Taxiway
Deadline for submitting complaints about scoring errors detected at the award ceremony	Within 5 days after the end of the competition	www.aeroct.com.br

1 - The Committee advises teams to submit propeller project reports as soon as possible so that there is enough time for the Committee's analysis and decision on whether to approve or not before submitting the project report.

2 - Starting from 2024, the pilot registration form or notice if an SAE pilot will be needed must be filled out and submitted within AeroCT in an area to be released at the appropriate time.

3 - The competition date is preliminary and a final confirmation from the DCTA is pending. A message will be sent at the appropriate time confirming the definitive competition dates. Oral presentation dates and flight video submission depend on the competition date and may be changed according to the final date.

Appendix 10. Operational Flowcharts

The following flowcharts aim to detail in a graphic and comprehensive way all the procedures that each aircraft must go through in each of the batteries on the days of the Flight Competition and Oral Presentations.

Some minor changes may be necessary due to adjustments observed and made on-site, which may not be represented here. However, such changes, if they occur, will not affect the sequence in a general way, and the diagram below will remain valid.

These flowcharts have the following color code: Yellow = Hangars, Blue = Pre-Flight, Purple = Flight, Green = Post-Flight, and Gray = Additional Information or Final Action.



Figura 10.1: General Flowchart

CALL FOR INSPECTION



Figura 10.2: Call for Battery

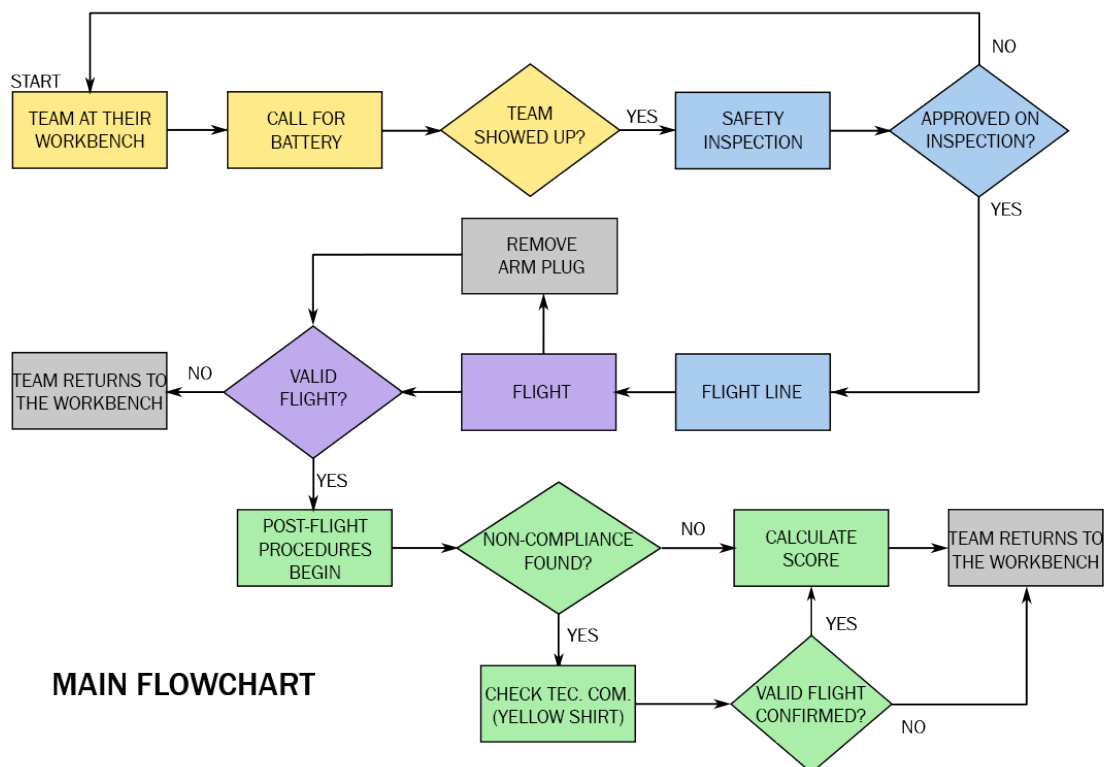

Only two members of the team and the pilot (if they are not a member of the team) may stay at the inspection tent.

Figura 10.3: Safety Inspection

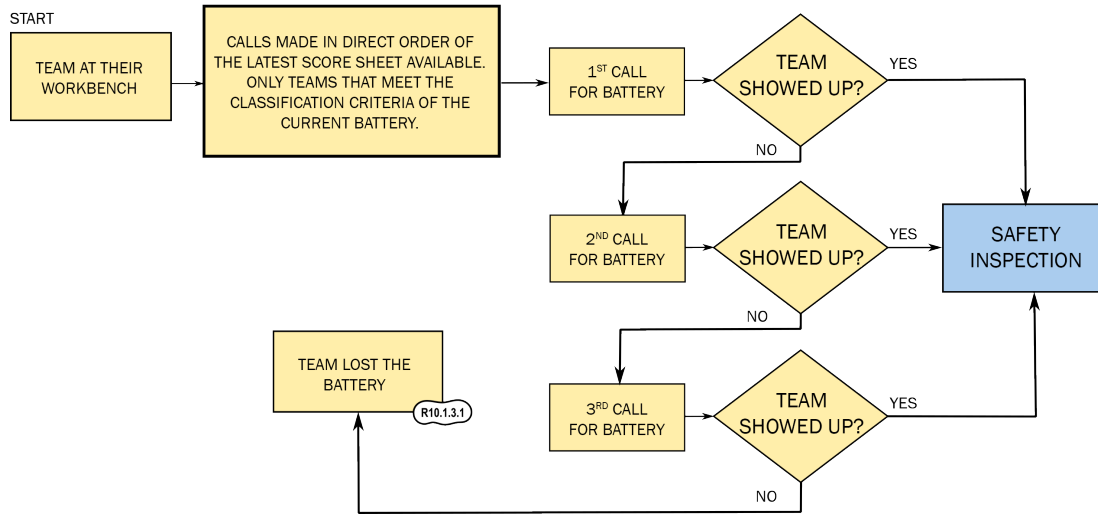
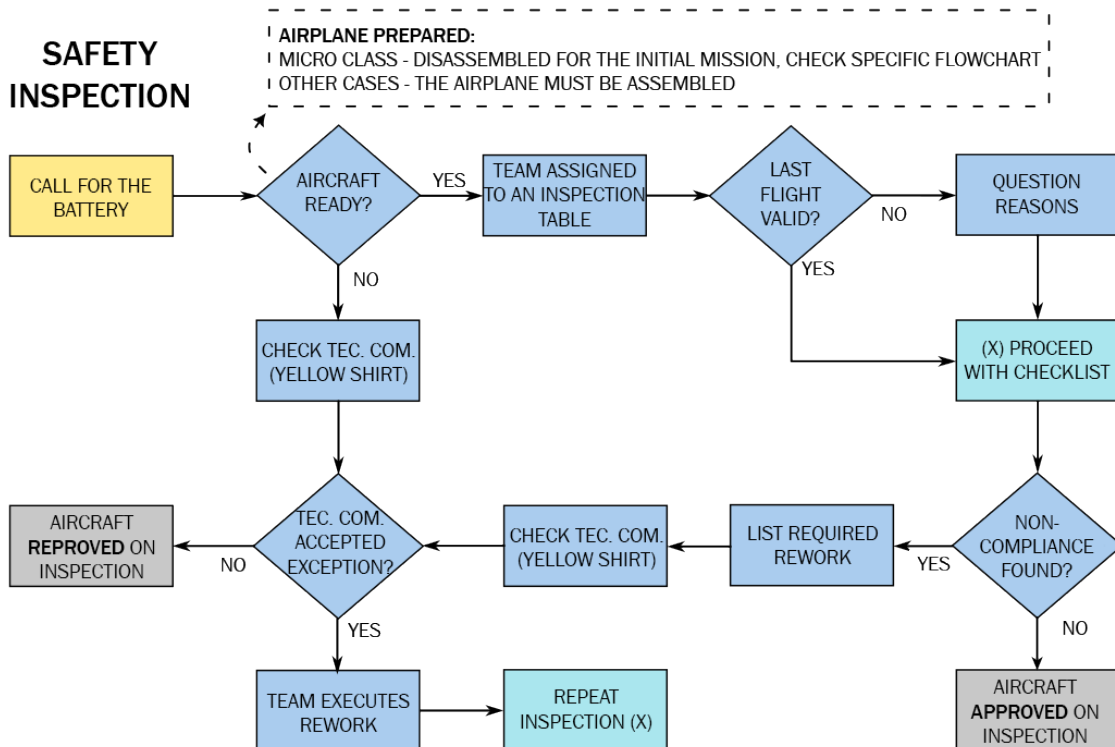

Figura 10.4: Flight - Regular Class

Appendix 11. Details of the Operational Structures



Figura 11.1: Obstacles for Regular and Advanced classes.

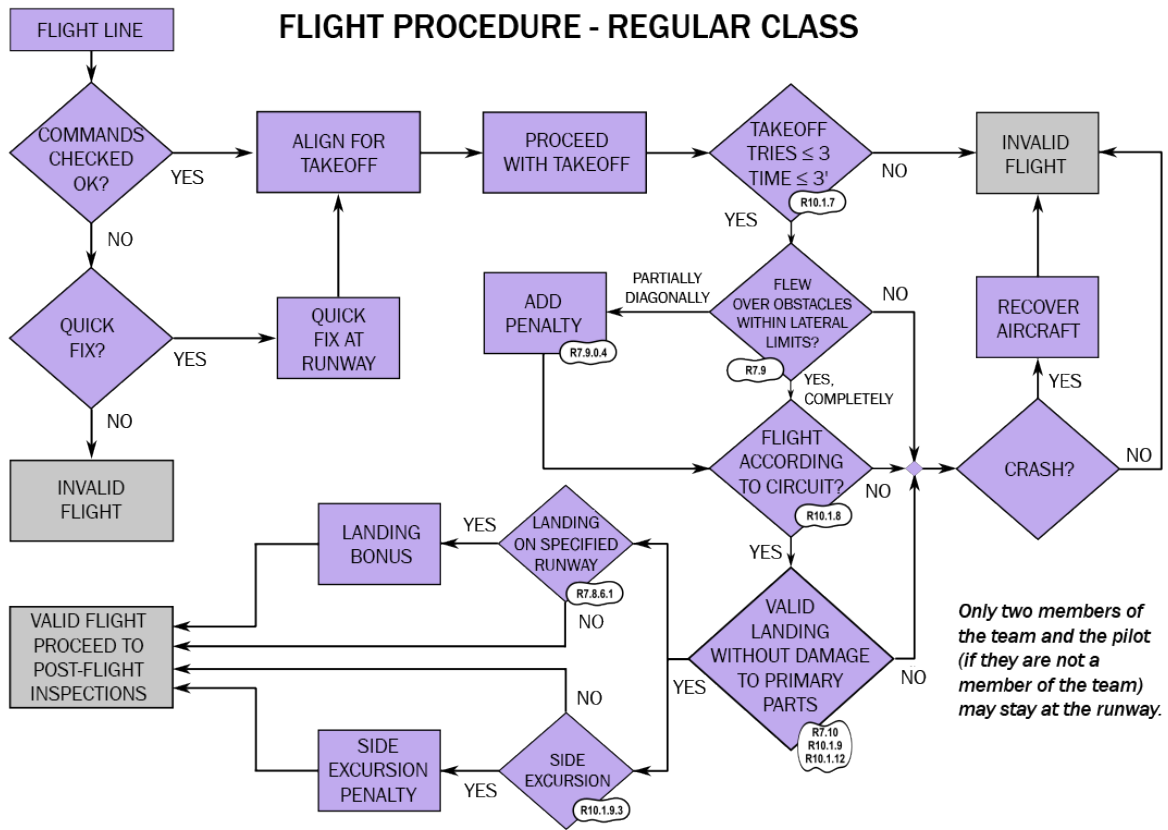

Figura 11.2: Platform for the Micro class. It will be leveled as best as possible on the grass.

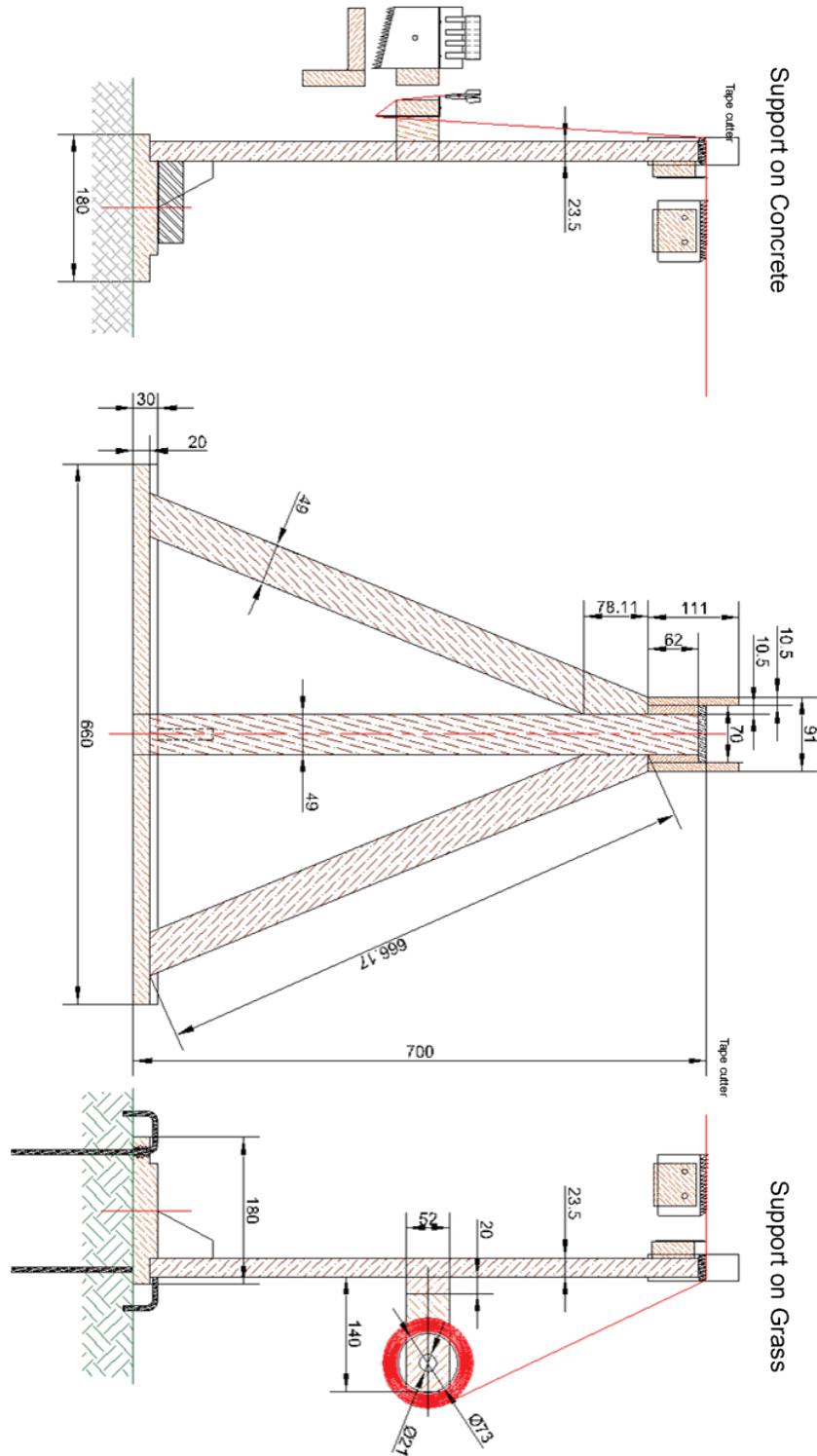

Appendix 12. Transmission and Telematics Network

12.1 Introduction

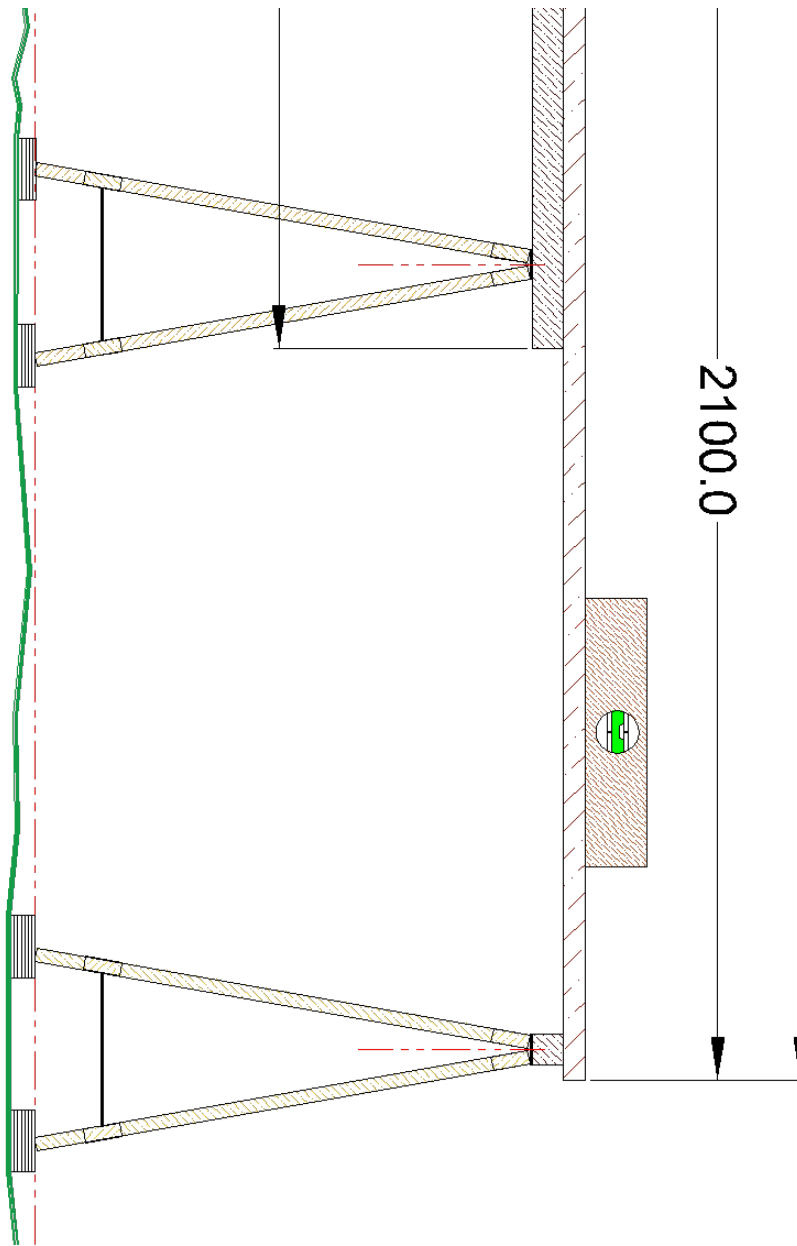
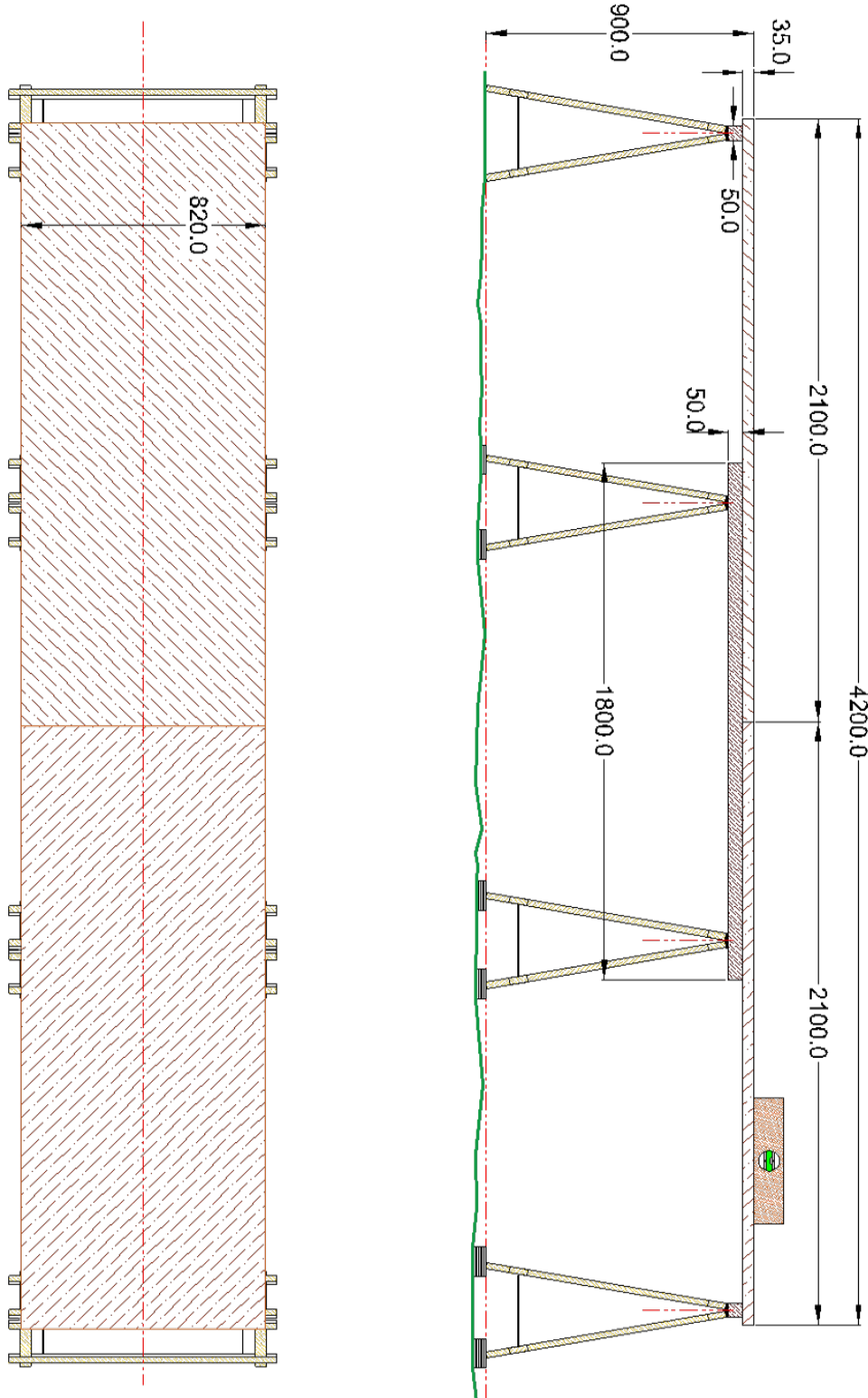
As part of the efforts to make the competition modern, digital, and faithfully represent the aerospace industry and the expectations for future engineers, the committee understands that the SAE Brasil AeroDesign competition will increasingly demand telemetry and real-time data assistance for control, decision-making, and aircraft evolution as well as for the fulfillment of current and future missions.

Recognizing the difficulty for teams to develop and maintain a stable and reliable communication network during the flight competition and anticipating potential spectrum, which is a finite resource, allocation issues in the competition environment as well as to avoid unwanted interference with the navigation aid equipment of the São José dos Campos airport and the Brazilian Air Force, the Technical Committee of the SAE Brasil AeroDesign Competition has developed and will operate an internal wireless communication network throughout the SAE Brasil AeroDesign 2024 competition.

This network will be available to teams on a best-effort basis, with no service level commitment in 2024. For this year, the Technical Committee will work to keep the network available during the flights of all teams, in all classes, and in all batteries, being optional for Regular and Micro class teams and mandatory for some missions of the Advanced class.

In case of intermittent operation of the communication system, the Technical Committee will work to restore its operation promptly to maintain equality among the teams as much as possible. If the Technical Committee believes that an intermittent operation results from a deliberate action by one or more team members or individuals directly or indirectly associated with a team, it may take punitive actions including disqualification of the team.

12.2 Physical Architecture

The system consists of 2 directional transceivers (Access Points) of IEEE 802.11g/n/ac/ax standard for coverage of the flight box at the approximate positions indicated in the following figures:



Figura 12.1: Transceivers positioning on the aeronautical chart of São José dos Campos airport



Figura 12.2: Transceivers positioning in satellite view

Both transceivers are interconnected through the network architecture represented in the following figure, forming a logically integrated network.

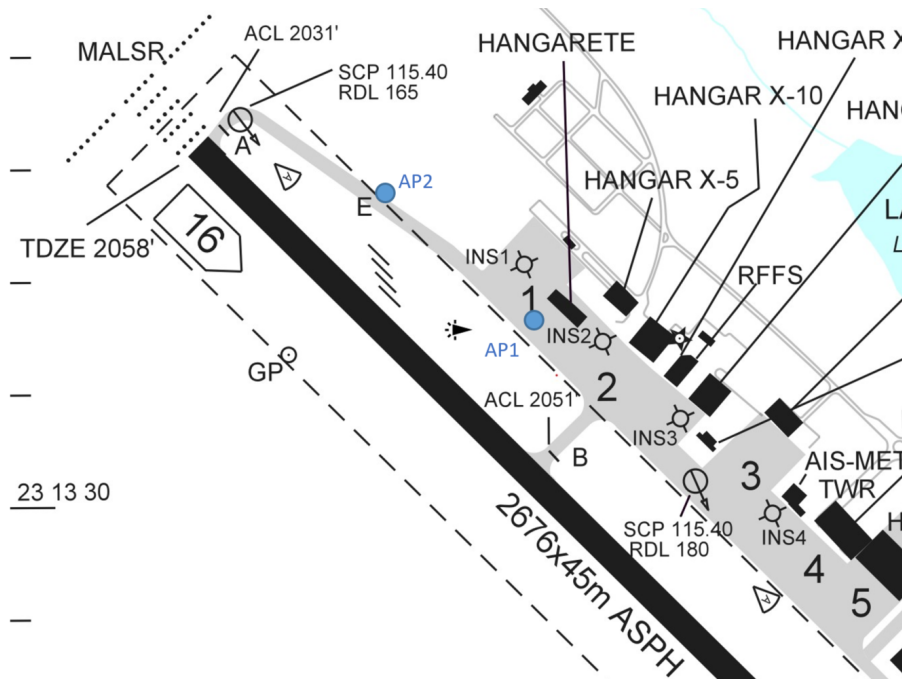

Figura 12.3: Logical representation of the network

Teams' access to the system will only be through the Wi-Fi network, with no wired interconnection to any of the routers allowed. For the 2024 competition, considering the inherent difficulties of multi-AP coordination for teams' terminal stations (roaming) – it is considered that the challenge of frequency coordination for the first year is sufficiently high, and the good signal intensity verified in field tests, both AP02 and RTR02 will not be available for team access.

12.3 Physical Characteristics of the Transceivers

The transceivers to be used are EAP660 HDs designed and manufactured by TP-Link Technologies Co., Ltd. (Building 7, Section 2, Honghualing Industrial Park Xili, Nanshan District, Shenzhen, China) with representation in Brazil through TP-Link Tecnologia do Brasil Ltda. (CNPJ: 12.667.763/0001-70). This equipment is approved by the Brazil's Anatel under number 06916-21-03177 and technical conformity certificate NCC 22634/21.

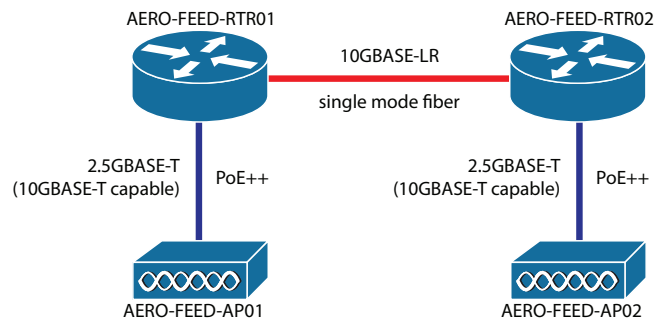
The equipment model operates in the frequency ranges of 2,400 to 2,483.5 MHz, 5,150 to 5,350 MHz, and 5,725 to 5,850 MHz using IEEE 802.11a/b/g/n/ac/ax communication standards with bandwidths of 20, 40, and 80 MHz in direct sequence or OFDM with CCK, BPSK, QPSK, 16-QAM, 64-QAM, 256-QAM, and 1024-QAM modulations with carrier aggregation and 4x4 MIMO internal antennas for its 2 radios (1 for the low band, 2.4 GHz, and another for the high band, 5 GHz) along with electronic beamforming through phase control of these antennas. For the low band, the antennas have a directivity of 4 dBi and for the high band, 5 dBi with transmitters of 26 dBm always. It is important to note that operations in CCK were administratively disabled by the committee, making the equipment incompatible with intentionally IEEE 802.11b stations, aiming for rational use of network allocation times.

Aiming for better performance over long distances, a bandwidth of 20 MHz will be used in the 2.4 GHz band operating on channel 6 (2.426 ~ 2.448 MHz), thus, teams' own networks (whether analog video transmitters, other Wi-Fi networks – except narrow-band commercial transmitters for radio-controlled model aircraft control) operating on interfering channels of channel 6, i.e., channels 2, 3, 4, 5, 6, 7, 8, 9, and 10, and frequencies coinciding with channel 6 and its guard band are prohibited. This implies that 2.4 GHz networks with 40 MHz bandwidth are prohibited in the competition.

Aiming for more available bandwidth and low latency, an 80 MHz bandwidth will be used in the 5 GHz band operating on channel 155 (5.735 ~ 5.815 MHz) with control channel 153 (central frequency 5.765 MHz), thus, teams' own networks (whether analog

video transmitters, other Wi-Fi networks) operating on interfering channels of channel 155, i.e., channels 149 to 163 inclusive, are prohibited.

The following are the transmitter output powers for the listed and approved modes:

Tabela 12.1: Emission data for 2.4 GHz

TX Fre- quency Range (MHz)	Maximum Output Power (W)	Emission Designation	Technology	Modulation Type	Maximum Transmission Rate
2,400 - 2,483.5	0.4645	16M5X9D	OFDM 802.11g	BPSK QPSK 16-QAM 64-QAM	54 Mbit/s (64-QAM)
	0.5358	17M8X9D	OFDM 802.11n (20 MHz)	BPSK QPSK 16-QAM 64-QAM	288.8 Mbit/s (64-QAM)
	0.5794	19M1X9D	OFDM 802.11ax (20 MHz)	BPSK QPSK 16-QAM 64-QAM 256-QAM 1024-QAM	573.5 Mbit/s (1024-QAM)

Tabela 12.2: Emission data for 5 GHz

TX Frequency Range (MHz)	Maximum Output Power (W)	Emission Designation	Technology	Modulation Type	Maximum Transmission Rate
5.725 - 5.850	0.3475	16M4X9D	OFDM 802.11a	BPSK QPSK 16-QAM 64-QAM	54 Mbit/s (64-QAM)
	0.4009	17M8X9D	OFDM 802.11n (20 MHz)	BPSK QPSK 16-QAM 64-QAM	288.8 Mbit/s (64-QAM)
	0.3758	36M6X9D	OFDM 802.11n (40 MHz)	BPSK QPSK 16-QAM 64-QAM	600 Mbit/s (64-QAM)
	0.3890	17M8X9D	OFDM 802.11ac (20 MHz)	BPSK QPSK 16-QAM 64-QAM 256-QAM	346.8 Mbit/s (256-QAM)
	0.3776	36M7X9D	OFDM 802.11ac (40 MHz)	BPSK QPSK 16-QAM 64-QAM 256-QAM	800 Mbit/s (256-QAM)
	0.3556	76M4X9D	OFDM 802.11ac (80 MHz)	BPSK QPSK 16-QAM 64-QAM 256-QAM	1733.32 Mbit/s (256-QAM)
	0.4634	19M2X9D	OFDMA 802.11ax (20 MHz)	BPSK QPSK 16-QAM 64-QAM 256-QAM 1024-QAM	573.5 Mbit/s (1024-QAM)
	0.4416	38M4X9D	OFDMA 802.11ax (40 MHz)	BPSK QPSK 16-QAM 64-QAM 256-QAM 1024-QAM	1147 Mbit/s (1024-QAM)
	0.4159	77M9X9D	OFDMA 802.11ax (80 MHz)	BPSK QPSK 16-QAM 64-QAM 256-QAM 1024-QAM	2402 Mbit/s (1024-QAM)

For the same equipment, the radiation diagrams of the set are provided:



Figura 12.4: Radiation diagram for 2.4 GHz



Figura 12.5: Radiation diagram for 5 GHz low band

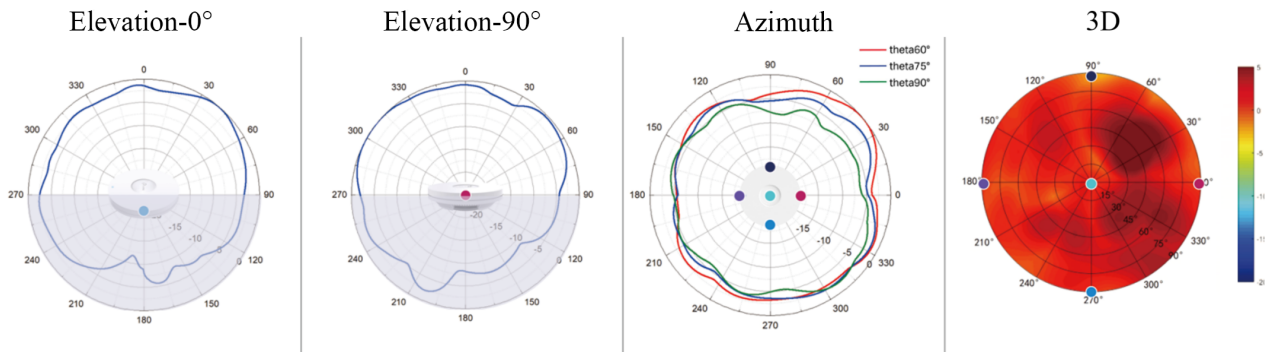

Figura 12.6: Radiation diagram for 5 GHz medium band

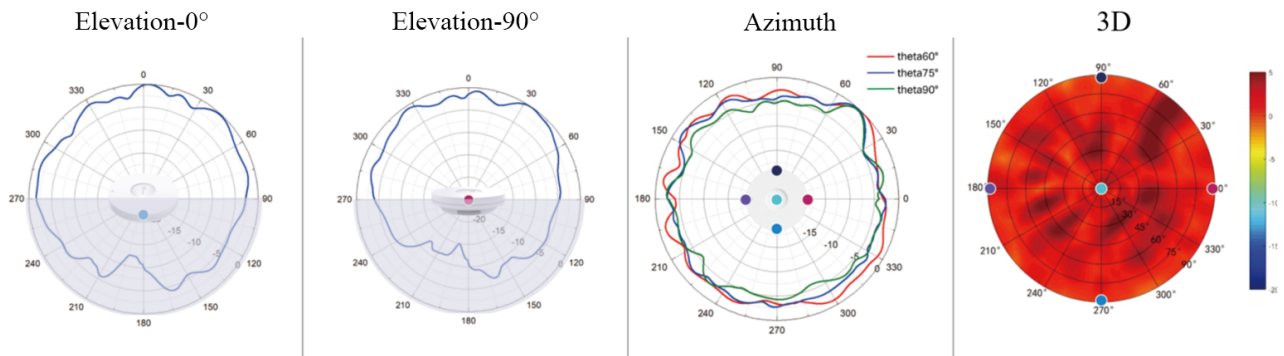

Figura 12.7: Radiation diagram for 5 GHz high band

The equipment is mounted vertically with the 0° azimuth position (burgundy point of the radiation diagram) closest to the ground and facing the flight box with its maximum power axis perpendicular to the track with a mechanical uptilt of 15°, the option, provided by the manufacturer, that best suits the already listed coverage objectives, maximizing coverage in the flight box while minimizing coverage in areas unrelated to the event, as shown in the figure below.

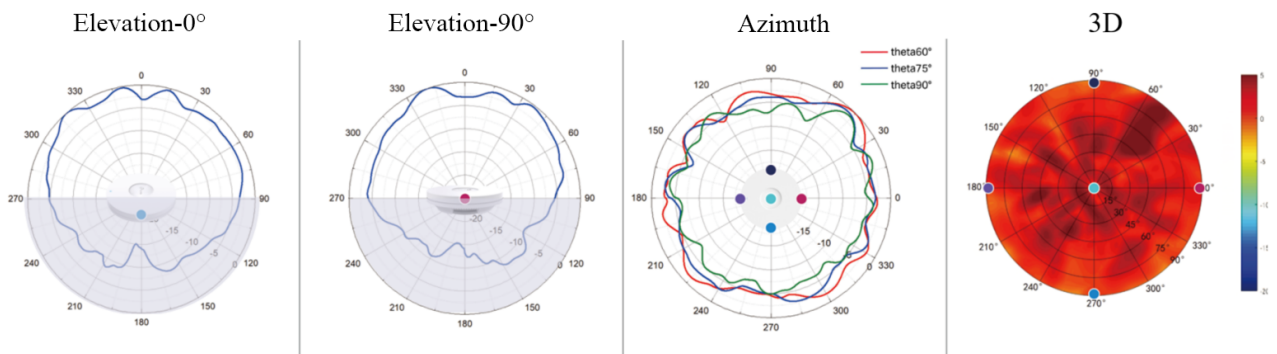

Figura 12.8: Transceiver installation options

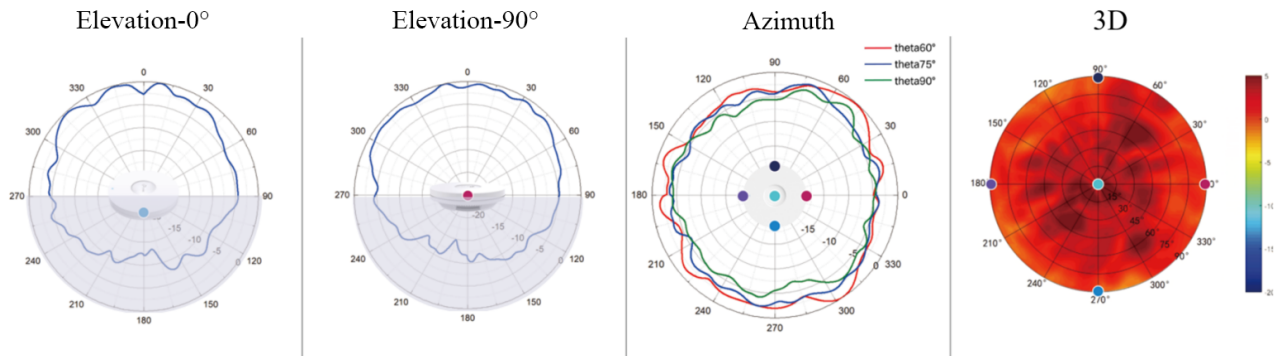
In the 2023 competition, the committee conducted a coverage test of AP01 using an approximately isotropic mobile meter at a height of 1.5 m above ground level in the 5 GHz range, obtaining the following results, not obtaining measured values below -73 dBm at any point in the test:

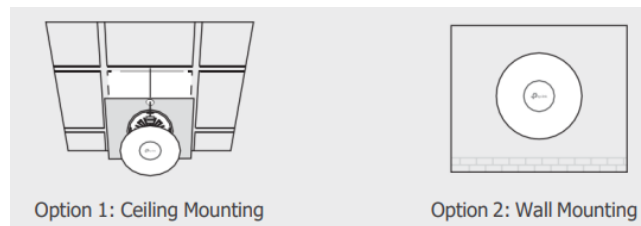

Figura 12.9: RSSI Measurement for AP01

Even though the field measurement results in good performance for the critical area of the flight box in an isotropic antenna, the committee recommends the use of antenna architectures that prioritize the lower semi-isotropic space of the aircraft.

12.4 Access Network

As indicated earlier, the access network is operated through a standard IEEE 802.11g/n/ac/ax (Wi-Fi 3,4,5,6) network with 802.11d/i/r extensions without WPS support and with 4x4 MIMO. Although the network is capable of operating in 4x4 MIMO, the committee recommends using a maximum of 2x2 MIMO on the terminal stations of the teams because its aim was to specify more antennas on the fixed transceiver equipment in order to allow a better signal-to-noise ratio in the reception of data from the mobile stations of the teams, and not necessarily in the gain of throughput through multi-path parallelization.

The technical committee chose the Wi-Fi 6 standard because it understands that the amplifiers widely available in the market for this technology have a higher effectively radiated average power than available in previous versions and invites teams to adopt the standard as soon as possible.

The IEEE 802.11be (Wi-Fi 7) standard aims to bring features that would improve the reliability of the access network, notably multi-link operation (MLO) and multi-AP coordination for joint transmission (JTX). If these implementations are confirmed in commercially viable products, the Technical Committee will work to upgrade the access network to meet these standards quickly. This information is provided to assist teams in their system architecture planning and financial planning.

Access to the network is controlled through the standard WPA2-Enterprise with the PEAP protocol, so each team will receive a user+password pair that will allow multiple accesses to a network with a unique SSID "AERO-FEED". Virtually, the network accessed by each team is unique, isolated (Layer 2 separation), and encrypted, so there is no intentional traffic between teams as well as any communication with the internet.

Given the inherent insecurities of the standard WPA2-Enterprise, this standard will be disabled for 2025, with the WPA3-Enterprise standard being used thereafter, thus losing compatibility with the 802.11r extension.

The certificate used for network security is self-signed by the technical committee and has the following fingerprints:

Here's the continuation of the translated text in LaTeX format:

Certification Authority

X509v3 Subject Key Identifier: 56:61:65:23:E1:3B:7B:35:CD:11:A1:AA:59:85:60:A8:EF:52:17:CC

SHA1 Fingerprint: 2A:A3:2D:29:6C:EE:72:22:D4:9E:EE:68:6A:01:64:CE:41:B1:54:D7

sha256 Fingerprint: 64:99:E9:63:74:62:E8:7E:1F:58:D5:80:63:7C:3D:9A:62:35:4A:D2:7E:EA:DA:02:4F:1F:1B:C2:10:D8:45:3D

md5 Fingerprint: 96:5A:A6:08:70:C8:1B:C7:B9:72:3B:85:F8:01:5F:96

Server

X509v3 Subject Key Identifier: 43:63:61:F5:47:0E:1E:7E:72:05:51:C0:56:10:D2:8D:6B:B5:16:5

SHA1 Fingerprint: E6:F5:68:F0:02:73:86:A1:F4:2B:E2:4F:E2:9F:63:01:E1:2D:77:67

sha256 Fingerprint: 3B:BB:8E:CF:26:5C:18:F5:C6:73:0B:33:92:83:C0:CD:10:14:A3:96:9F:9F:B5:2C:09:2B:A2:C0:46:0E:0A:88

md5 Fingerprint: 09:EB:1A:89:CA:C4:62:04:3C:78:CF:7A:AC:9B:7B:CD

The certificate can be obtained at <https://aeroct.com.br/certificates/server.crt>, and the certification authority's revocation list is available at <https://aeroct.com.br/certificates/ca.crl>.

If any team feels the need for additional information regarding the access network to carry out their own configurations or simulations, they should submit the request via the AeroCT question form, which will be analyzed and eventually responded to.

12.5 Associated Services

DHCP/DHCPv6

A single DHCP server will be provided per team, which will provide IPv4 addresses within the allocated pool for each team along with gateway information, DNS suffix (.aero-feed), DNS server, and NTP server.

For IPv6, the method of obtaining IPv6 addresses is through SLAAC+RA, with the DHCPv6 server in stateless mode for providing DNS suffix (.aero-feed), DNS server, and NTP server information. The entire AERO-FEED system operates in dual-stack.

NTP/NTS

An NTP/NTS time server will be provided for clock synchronization. The committee will work to maintain the time of this server accurately through synchronization with atomic clocks from the Brazilian National Observatory and multiple constellations of inertial navigation systems. However, its time should not be used as a source for any telemetry missions of the competition as deviations in this clock are expected during the competition.

The certificate used for NTS communication security is the same as that used for access network security.

Address: TIME.aero-feed

IPv4: 10.40.2.254

IPv6: FD18:AE20:FEED:4002:1:1:1:1

DNS/DoT/DoH

A server for name resolution compatible with DNS/DoT/DoH protocols and their respective RFCs will be provided. This name server may or may not resolve external addresses, guaranteeing only the ability to resolve relevant addresses of the aero-feed network and reverse addresses of the pools provided to the teams.

The certificate used for DoT/DoH communication security is the same as that used for access network security.

Here's the continuation of the translated text in LaTeX format:

Address: NAME.aero-feed

IPv4: 10.40.1.254

IPv6: FD18:AE20:FEED:4001:1:1:1:1

Service API

The service API is used to inform/receive mission information from teams through an HTTP/HTTPS endpoint with support for GET and POST requests with JSON encoding. The effective use of the API is directly linked to the desired mission and will be explained together with the mission.

Address: AERO-FEED-SERVICES.aero-feed

IPv4: 10.40.20.254

IPv6: FD18:AE20:FEED:4020:1:1:1:1

Multicast

Multicast services are supported and encouraged, especially for video services, with an IGMPv3 proxy available per team. Additional details on usage and address ranges will be provided in a future rules review.

12.6 Unicast IP Address Range

Team IP addresses will be provided by the DHCP server provided to the team by the committee and via SLAAC, but to facilitate team planning, team address ranges are predetermined following these formation rules:

IPv4: 10.1<team number hundred>.<team number ten and unit>.0/24, with the gateway always at address 1.

IPv6: FD18:AE20:FEED:1<team number>::/64 with the gateway at its address determined by SLAAC+RA.

Examples:

Team 1:

IPv4: 10.10.1.0/24

IPv6: FD18:AE20:FEED:1001::/64

Team 2:

IPv4: 10.10.2.0/24

IPv6: FD18:AE20:FEED:1002::/64

Team 101:

IPv4: 10.11.1.0/24

IPv6: FD18:AE20:FEED:1101::/64

Team 201:

IPv4: 10.12.1.0/24

IPv6: FD18:AE20:FEED:1201::/64